



節亮康復產品有限公司產品手冊

# Health Product

Your Smart Health Care Solution Partners  
Health care product | Smart home care | Air purification

## UVC Series

Z2

Ziglite Smart Health Care Products Co., Ltd.





**Z** IGLITE<sup>®</sup>  
HEALTHCARE



**Ziglite Smart Health Care Products Co., Ltd.**

**節 亮 康 護 產 品 有 限 公 司**

# Company Profile

## 公司簡介

### ● ABOUT US 關於我們

Ziglite Smart Health Care Products Co., Ltd. Incorporated in 2018, we work with our partners to bring their products to the local market. Mainly engaged in the management of health care products, the main customers are hospitals and clinics, homes for the elderly and home patients.

We are committed to the development of excellent health care products, dedicated to the needs of a wide range of different customers, get the best care in the family treatment process, and greatly improve the effect of rehabilitation. Get the best care during the family treatment process and greatly improve the healing effect. We will provide quality products with stable quality and stable performance for customers.

We specialize in a wide range of products including: anti-virus and air freshening, incontinence care, mobility aids, decompression supplies... supplies.

於2018年成立，我們與合作夥伴一起把他們的產品推向本地市場。以經營康護用品為主，主要客戶為醫院及診所，安老院及家居病人等。

我們致力於發展卓越的康護醫療產品，竭誠照顧廣大不同客戶的需要，在家庭治療過程中得到最好的護理，大大提高康復治療效果。在家庭治療過程中得到最好的護理，大大提高康復治療效果。務求為客戶提供品質優越及性能穩定的醫療產品。

我們專營的產品種類繁多，包括：抗病毒及空氣清新，失禁護理，助行用品，減壓用品...用品等。



**Z** IGLITE<sup>®</sup>  
HEALTHCARE



# CONTENTS

01

**LED UVC Antivirus Sterilizer**  
LED UVC殺菌消毒燈系列

14

**Mercury Lamp,  
Ozone Series**  
汞燈、臭氧殺菌消毒燈系列

33

**UVC Application  
Products**  
UVC應用產品

53

**Air Purification**  
空氣淨化

# A

## LED UVC Antivirus Sterilizer LED UVC殺菌消毒燈系列



P2 CAA



P3 CAB



P4 CAC



P5 CAD/CAE



P6 CAF



P7 CAG



P8 CAH



P9 CAI



P10 CAJ



P11 CBQ



P12 CBP



P13 CZ

# B

## Mercury Lamp, Ozone Series 汞燈、臭氧殺菌消毒燈系列



P15 CAK



P16 CAL



P17 BR

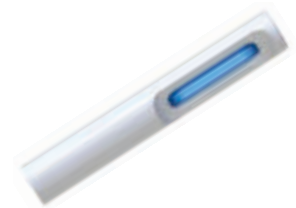

P18 CE



P19 BB



P20 BI



P21 BJ



P22 BF



P23 BK



P24 CAM



P25 CAN



P26 AU



P27 AX



P28 C8



P29 C5



P30 CH



P31 CAO



P32 FE

# C

## UVC Application Products UVC應用產品



P34 AD



P35 CX



P36 CBF



P37 CAQ



P38 CAX



P39 CAU



P40 CB



P41 CAR



P42 CV



P43 CY



P44 CAV



P45 CG



P46 CD



P47 CF



P48 CAW



P49 CBH



P50 CBI



P51 CBJ



P52 CBN

# D Air Purification 空氣淨化



P54 FAR



P55 AK



P56 AJ



P57 CBK



P58 FAQ



P59 FAI



P60 FB



P61 FAJ



P62 FAK



P63 CBD



P64 FAL



P65 CAP



P66 CBL



P67 CAP



P68 CBO



# Ultraviolet & Mercury Lamp & Ozone

## Antivirus Principle

### 紫外線, 汞燈及臭氧殺毒原理

#### Ultraviolet Rays

#### Understanding And Antivirus Principles

#### 紫外線認識及殺毒原理

Ultraviolet (Ultra Violet, UV) is very common. It is light with a wavelength of 100 to 400 nm in sunlight. According to different wavelengths, it can be divided into UVA, UVB, UVC and vacuum UV. Among them, the UVA wavelength range is 315-400 nm, the UVB wavelength range is 280-315nm, and the UVC wavelength range is 200-280nm.

The UVC band has the characteristics of short wavelength and high energy. It can penetrate the cell membrane and cell nucleus of organisms, cause damage to DNA, and destroy the molecular structure of microbial organisms (bacteria, viruses and other pathogens) in a short time. By damaging the DNA and RNA of microorganisms to prevent their reproduction, achieve high-efficiency and rapid broad-spectrum sterilization effects.

紫外線(Ultra Violet, UV)很常見,它是陽光中波長100至400 nm的光線,根據不同波段可分為UVA、UVB、UVC及真空UV。其中UVA波長範圍315-400 nm,UVB波長範圍280-315nm,UVC波長範圍200-280nm。

UVC波段具有波長短、能量高特點,能穿透生物的細胞膜和細胞核,對DNA造成損傷,短時間內破壞微生物機體(細菌、病毒等病原體)細胞中分子結構。通過破壞微生物的DNA和RNA阻止其繁殖,實現高效快速的廣譜殺菌效果。

## UVC Antivirus

### Advantages And Disadvantages

#### UVC殺毒優、缺點

UVC has the advantages of high efficiency, broad spectrum, more thorough sterilization, environmental protection, no drug resistance and no secondary pollution;

However, the main parts of UVC UV damage to human body are eyes and exposed skin. Short term high-intensity irradiation can burn eyes and skin, and the penetration is very weak. Ordinary transparent glass, clothes, plastic, dust and so on can be completely blocked.

UVC高效率殺菌，殺菌廣譜性，殺菌更徹底，完全環保，不存在抗藥性，無二次污染；

但是UVC紫外線對人體傷害的主要部位是眼睛、裸露的皮膚，短期高強度照射可灼傷眼睛及皮膚，穿透力極弱，普通透明玻璃、衣服、塑膠、塵埃等均能完全阻擋。

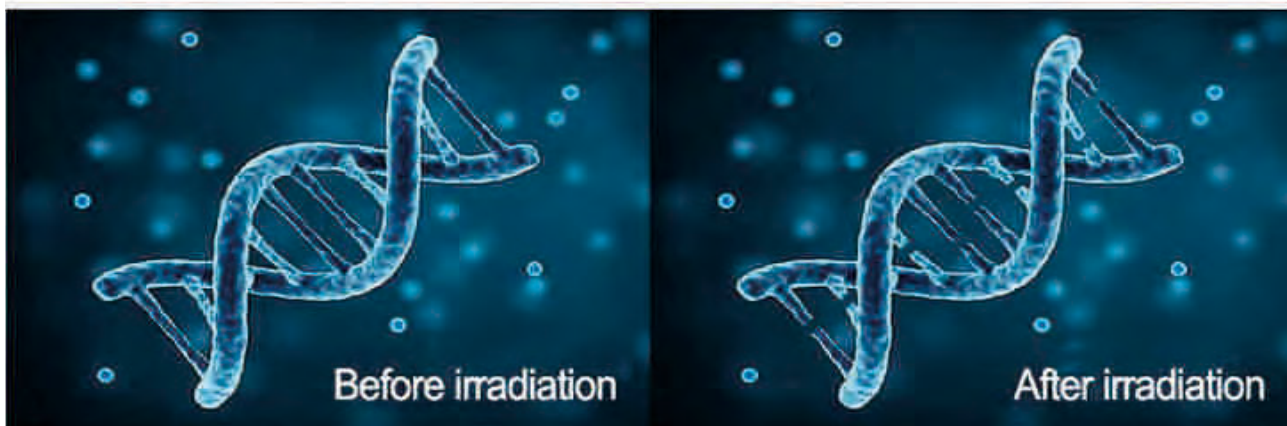
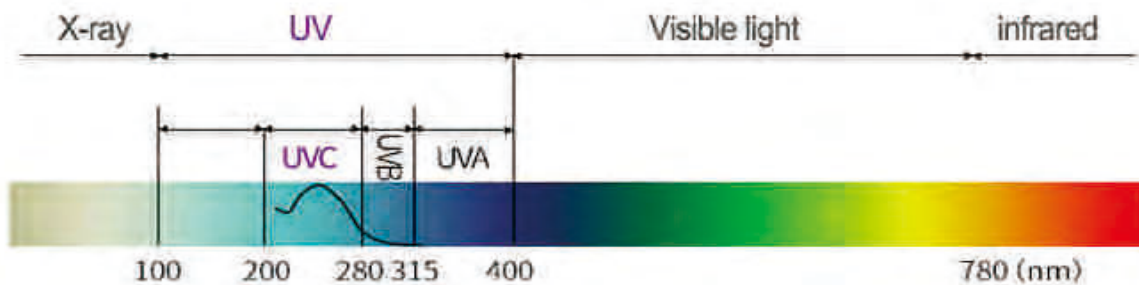

## Deep UV LED

# Antivirus Principle And Application

### 深紫外LED殺毒原理及應用

Deep-ultraviolet LED (UVC LED) is a sterilizing ultraviolet diode, and LED refers to the way to emit UVC, which has the performance advantages of safety, environmental protection, compactness, high efficiency, and low consumption. Our products use UVC LED to emit deep ultraviolet light with a wavelength of 260~280nm. Deep ultraviolet can destroy the DNA or RNA molecular structure of the genetic material in microorganisms, causing bacteria to be unable to reproduce or even inactivate, thereby achieving the purpose of sterilization.

深紫外 LED (UVC LED) 就是殺菌紫外線二極管，而LED發出UVC的方式，具有安全、環保、小巧、高效、低耗等性能優勢。我司產品所用 UVC LED 能發出波長260~280nm的深紫外線，深紫外線能破壞微生物體內遺傳物質DNA或者RNA分子結構，導致細菌無法繁殖甚至失活，從而達到殺菌消毒的目的。

## Mercury Lamp

# Principle Of Disinfection

### 汞燈殺毒原理

Mercury lamp is actually a kind of low-pressure mercury. The low-pressure mercury lamp emits ultraviolet wave by making use of lower mercury vapor pressure ( $< 10\text{-}2\text{Pa}$ ). There are two main emission lines: one is 253.7nm, the other is 185nm wavelength, both of which are invisible to the naked eye. The wavelength of 250nm-260nm can play a very good bactericidal effect, so the ultraviolet ray with 253.7nm wavelength is transmitted through the glass tube wall to achieve the purpose of ultraviolet sterilization.

Mercury lamp sterilization is widely used at present. However, mercury is highly toxic. Mercury can evaporate at room temperature, and mercury vapor and mercury compounds are highly toxic (chronic). In the process of sterilization of traditional ultraviolet mercury lamp, once the lamp tube breaks, it will cause serious water pollution, which will lead to serious consequences if it is not well controlled.

汞燈殺毒實際上是屬於一種低壓汞，低壓汞燈是利用較低汞汽壓( $<10\text{-}2\text{Pa}$ )被激發而發出紫外波，其發光譜線主要有兩條：一條是253.7nm波長；另一條是185nm波長，這兩條都是肉眼看不見的紫外線。250nm-260nm波長能起到很好的殺菌作用，因此波長253.7nm的紫外線穿過玻璃管壁透射出來，實現紫外線殺菌的目的。

汞燈殺菌是目前使用比較廣泛的殺菌方式。但是汞含有劇毒，汞在常溫下即可蒸發，汞蒸氣和汞化合物有劇毒（慢性），傳統紫外汞燈殺菌燈在殺菌過程中，一旦燈管破裂，將引起嚴重的水質污染，控制不好會產生的嚴重後果。

## Ozone

# Principle Of Disinfection

## 臭氧消毒原理

At room temperature, ozone is a kind of light purple gas with special fishy smell, and its solubility increases with the decrease of temperature. Due to its strong oxidation property, ozone has outstanding bactericidal, disinfection and pesticide degradation effects. It is a kind of high-efficiency broad-spectrum fungicide.

Ozone is a strong oxidant, and the sterilization process belongs to biochemical oxidation reaction. Ozone sterilization has the following three forms:

1. Ozone can oxidize and decompose the enzymes needed to degrade glucose in bacteria, which makes the enzymes necessary for cell activity lose their activity and kill the bacteria.
2. It can directly interact with bacteria and viruses, destroy their organelles, DNA and RNA, and destroy the metabolism of bacteria, leading to bacterial death.
3. The lipoproteins and lipopolysaccharides acting on the outer membrane and the lipopolysaccharide inside the cell membrane can change the permeability of the cell, resulting in cell dissolution and death.

Ozone diffuses quickly and evenly in the air, and there is no dead corner in disinfection. Its disadvantages: the sterilization time is long, generally 50 ~ 60min; in addition, if there is water on the surface of the articles to be disinfected, the ozone disinfection effect will be weakened.

在室溫下，臭氧氣是一種呈淡紫色的、有特殊魚腥味的氣體，隨著溫度的降低而溶解度增加。由於臭氧具有強氧化性，呈現出突出的殺菌、消毒、降解農藥的作用，是一種高效廣譜殺菌劑。

臭氧是一種強氧化劑，滅菌過程屬生物化學氧化反應。臭氧滅菌有以下3種形式：

1. 臭氧能氧化分解細菌內部降解葡萄糖所需的酶，使細胞活動必需的酶失去活性，使細菌滅活死亡。
2. 直接與細菌、病毒作用，破壞它們的細胞器和DNA、RNA，使細菌的新陳代謝受到破壞，導致細菌死亡。
3. 透過細胞膜組織，侵入細胞內，作用於外膜的脂蛋白和內部的脂多糖，改變細胞通透性，導致細胞溶解、死亡。

臭氧在空氣中彌漫快而均勻，消毒無死角。其缺點：殺菌時間較長，一般應達到50~60min；另外，如果待消毒的物品表面有水，會使臭氧消毒作用減弱。

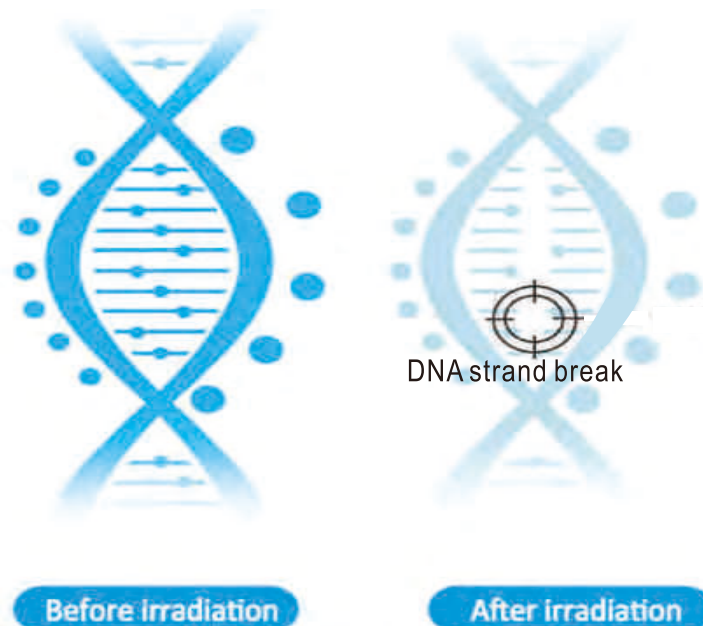

---

# LED UVC

# Antivirus Sterilizer

## LED UVC殺菌消毒燈系列



# LED UV Anti-virus Lamp

## LED紫外線殺毒燈 (3燈)

Model: CAA

### Features:

- LED UV anti-virus stick, sterilization rate 99.9%
- Smart shutdown in 5 minutes
- Suitable for household wardrobe, shoe cabinet, bed, underwear, carry-on items, baby supplies, car and other sterilization
- LED紫外線防毒棒, 殺菌率99.9%
- 5分鐘工作智能關機
- 適用於家用衣櫃, 鞋櫃, 床, 內衣, 隨身物品, 嬰兒用品, 汽車等殺菌

### Specifications

Product Model 產品型號	CAA
Product Function 產品功能	Sterilization disinfection 殺菌消毒
Product Material 產品材質	ABS
Power 功率	1.5W
LED	3pcs 3535 LED
Wavelength 波長	270-280nm 295-400nm UVC + UVA dual wave UVC + UVA雙波
Power supply 電源供應	USB charging / 18650 lithium battery USB充電 / 18650鋰電池
Color selection 顏色選擇	White, rose gold
Size 尺寸	140 * 35 * 25mm
Weight 重量	87g

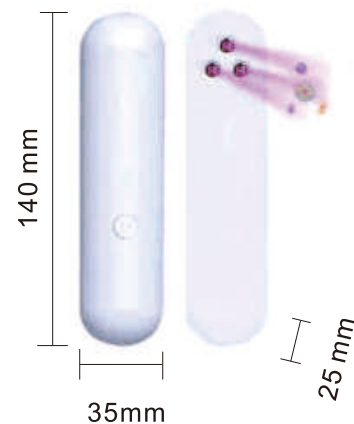

### Instructions

Click to start disinfection, click again to stop, sweep back and forth against the disinfected items 5-10 times, it is recommended to sweep evenly at a distance of 3cm

**Warning: Do not irradiate eyes and skin**

單擊開啟消毒, 再次單擊停止, 對著消毒物品來回掃動5-10次, 建議距離3cm均勻掃動

**警告: 禁止照射眼睛和皮膚**



# LED Ultraviolet Antivirus Stick

## LED紫外線殺毒棒 (8燈)

Model: CAB

### Features:

- Use deep UV LED, the sterilization rate was 99.9%;
- Easy to carry; Simple operation, click the button to start; Built in child lock protection device;
- The product has gravity induction, and the lamp is turned off in reverse direction. When the lamp bead is more than 90 ° upward, the lamp bead goes out and stops working, and starts working when it goes down again
- It is suitable for disinfection of family wardrobe, shoe cabinet, bed, underwear, carry on items, baby products, automobiles, etc.
- 使用深紫外LED, 殺菌率為99.9%;
- 攜帶方便; 操作簡單, 點擊按鈕即可啟動; 內置兒童鎖保護裝置;
- 產品具有重力感應, 反向熄燈, 燈珠向上 >90° 時, 燈珠熄滅停止工作, 再次向下時開始工作
- 適用於家庭衣櫃, 鞋櫃, 床, 內衣, 隨身物品, 嬰兒用品, 汽車等的消毒。

### Specifications

Product Model 產品型號	CAB
Product Function 產品功能	Sterilization disinfection 殺菌消毒
Product Material 產品材質	ABS
Power 功率	4W
Wavelength 波長	260-280nm
LED quantity 數量	LED 8pcs
Power supply 電源供應	USB charging/18650 lithium battery USB充電/18650鋰電池
Disinfection time 消毒時間	10S
Life time 續航時間	10000h
Size 尺寸	265 * 40 * 25mm
Weight 重量	160g

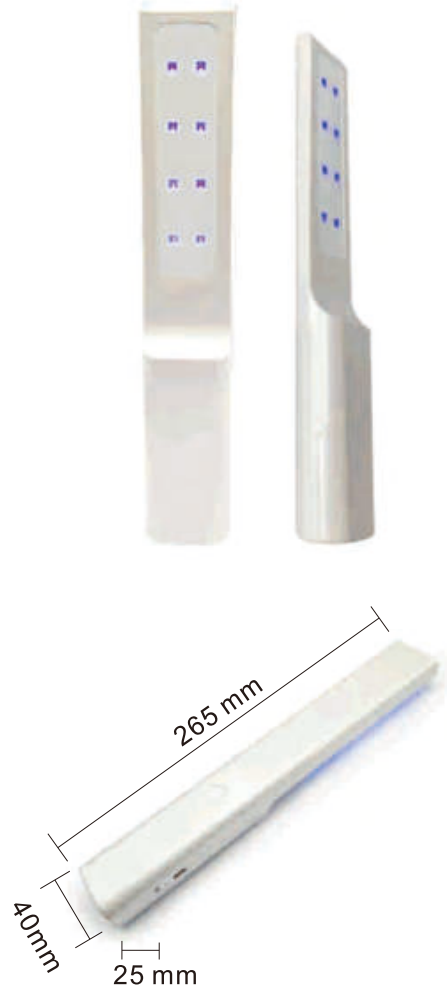

### Instructions

Click the power button to turn on antivirus, swipe back and forth at the item 5-10 times, click the button for the second time to close

**Warning: Do not irradiate eyes and skin**

單擊開關鍵開啟殺毒, 對著物品來回掃動5-10次, 第二次單擊按鍵關閉

**警告: 禁止照射眼睛和皮膚**

# Folding LED Ultraviolet Antivirus Stick

## 折疊式LED紫外線殺毒棒 (16燈)

Model: CAC

### Features:

- Use deep UV LED, the sterilization rate was 99.9%;
- Light folding, easy to carry; Simple operation, click the button to start;
- Built in child lock protection device;
- The product has gravity induction, and the lamp is turned off in reverse direction. When the lamp bead is more than 90 ° upward, the lamp bead goes out and stops working, and starts working when it goes down again
- It is suitable for disinfection of family wardrobe, shoe cabinet, bed, underwear, carry on items, baby products, automobiles, etc.
- 使用深紫外LED, 殺菌率為99.9%;
- 輕巧折疊, 攜帶方便; 操作簡單, 點擊按鈕即可啟動;
- 內置兒童鎖保護裝置;
- 產品具有重力感應, 反向熄燈, 燈珠向上 >90° 時, 燈珠熄滅停止工作, 再次向下時開始工作
- 適用於家庭衣櫃, 鞋櫃, 床, 內衣, 隨身物品, 嬰兒用品, 汽車等的消毒

### Specifications

Product Model 產品型號	CAC
Product Function 產品功能	Sterilization disinfection 殺菌消毒
Product Material 產品材質	ABS
Power 功率	9W
Wavelength 波長	260-280nm
LED	16pcs LED
Power supply 電源供應	USB charging/18650 lithium battery USB充電/ 18650鋰電池
Disinfection time 消毒時間	10S
Life time 續航時間	10000h
Size 尺寸	270 * 42 * 40mm
Weight 重量	198g

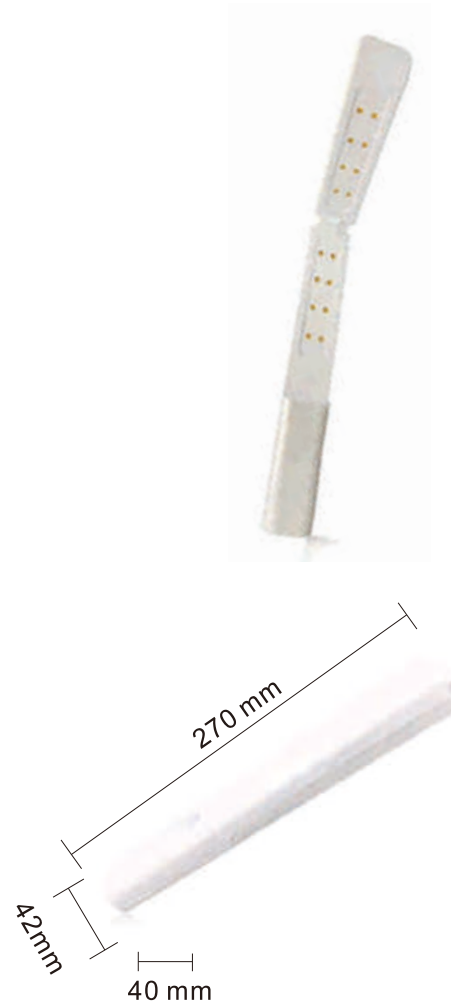

### Instructions

Click the power button to turn on antivirus, swipe back and forth at the item 5-10 times, click the button for the second time to close

**Warning: Do not irradiate eyes and skin**

單擊開關鍵開啟殺毒, 對著物品來回掃動5-10次, 第二次單擊按鍵關閉

**警告: 禁止照射眼睛和皮膚**

# Mini UV Anti-virus Lamp

## 迷你紫外線殺毒燈

Model: CAD/CAE

### Features:

- Micro-instant sterilization, high efficiency and energy saving, sterilization rate reaches 99.9%;
- Small and exquisite, easy to execute;
- UV UVC with high precision and special wavelength is used to sterilize and disinfect the surface of objects;
- System support: All versions of IOS system and Android phones need to support OTG function
- Suitable for: disinfection of personal belongings, etc
- 微瞬間殺菌, 高效節能, 殺菌率達到99.9%;
- 小巧精緻, 易於執行;
- 具有高精度和特殊波長的UV UVC用於對物品的表面進行滅菌和消毒;
- 系統支持: 所有版本的IOS系統, Android手機都需要支持OTG功能
- 適用於: 隨身物品等的消毒

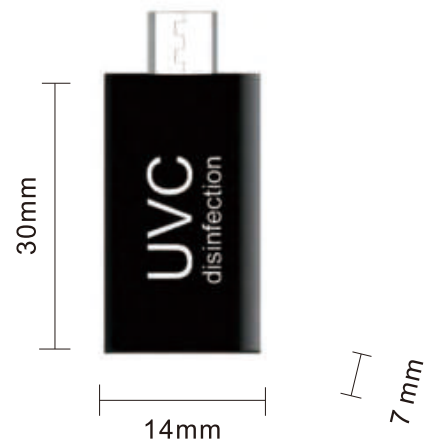

### Specifications

Product Model 產品型號	CAD/CAE
Product Function 產品功能	Sterilization disinfection 殺菌消毒
Power 功率	0.45W
Wavelength 波長	260-280nm
LED	1 UVC led, 2 ordinary LEDs 1個UVC LED, 2個普通LED
Input voltage 輸入電壓	Phone: DC3 7V, type-C: DC5V 電話: DC3 7V, C型: DC5V
Output voltage 輸出電壓	Phone: DC6V, type-C: DC6V 電話: DC6V, C型: DC6V
Life time 續航時間	10000h
Size 尺寸	30 * 14 * 7mm
Weight 重量	3g

### Instructions

Choose a suitable mobile phone to keep the screen lighting plug and play, keep the flash distance of 5mm, and scan slowly

與適用手機保持螢幕照明即插即用, 保持5mm閃光距離, 慢速掃描

# LED UV Anti-virus Lamp

## 輕便手持LED紫外線殺毒燈 (1燈)

Model: CAF

### Features:

- The effective sterilization rate was 99.9%
- Portable, easy to use
- Hard to clean health dead angle, fast and effective killing bacteria
- Use one (UVA + UVC) double wave ultraviolet LED lamp bead
- Suitable for: disinfection of personal belongings, etc
- 有效殺菌率為99.9%
- 便攜式, 易於使用
- 難以清潔的衛生死角, 快速有效地殺死細菌
- 使用一個 (UVA + UVC) 雙波紫外線LED燈珠
- 適用於: 隨身物品等的消毒

### Specifications

Product Model 產品型號	CAF
Product Function 產品功能	Sterilization disinfection 殺菌消毒
Product Material 產品材質	ABS
Voltage 電壓	5V
Power 功率	3W
Wavelength 波長	260-280nm
Battery capacity 電池容量	500mAH
Charging time 充電時間	1.5H
Size 尺寸	150 * 35 * 19mm
Weight 重量	80g

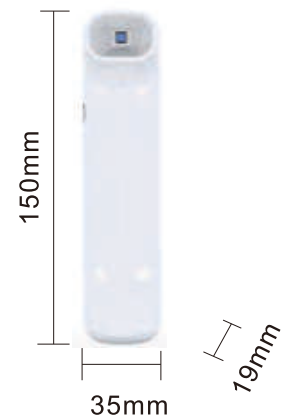

### Instructions

Click the switch and the light is on to enter the automatic antivirus mode (automatically shut down in 60 seconds) and sweep back and forth against the disinfected items 5-10 times. It is recommended to sweep evenly at a distance of 3cm. The second click enters the manual mode (automatically shuts off in 30 minutes). Three clicks to close manually.

**Warning: Do not irradiate eyes and skin**

單擊開關燈亮, 進入自動殺毒模式 (60秒自動關閉) 對著消毒物品來回掃動5-10次, 建議距離3cm均勻掃動, 第二次單擊進入手動模式 (30分鐘自動關閉), 第三次單擊手動關閉。

**警告: 禁止照射眼睛和皮膚**

# G1 LED Folding UVC Disinfection Stick

## G1 LED 折疊式紫外線消毒棒

Model: CAG

### Features:

- Using deep ultraviolet LED, 16 lamp beads, sterilization rate 99.9%;
  - Lightweight folding, easy to carry; simple operation, click the button to start;
  - Built-in child lock protection device, with gravity sensor design, when the ultraviolet light is upward, it will automatically shut off the ultraviolet light, which is safer;
  - It is suitable for disinfection of household wardrobes, shoe cabinets, beds, underwear, personal belongings, baby products, automobiles, etc.
- 採用深紫外LED, 16顆燈珠, 殺菌率99.9%;
  - 輕巧折疊, 方便攜帶; 操作簡單, 單擊按鈕即可啟動;
  - 內置童鎖保護裝置, 具有重力感應設計, 當紫外線朝上時, 自動閉紫外光, 更安全;
  - 適用於家庭衣櫃、鞋櫃、床、內衣、隨身物品、嬰兒用品、汽車等的消毒。



### Specifications

Product Model 產品型號	CAG
Product Function 產品功能	Sterilization disinfection 殺菌消毒
Power 功率	7W
Wavelength 波長	260-280nm
Charging method 充電方式	TYPE-C/lithium battery TYPE-C/鋰電池
Battery capacity 電池容量	2000mAh
Operation mode 操作方式	Button type 按鍵式
Disinfection time 消毒時間	10 s
Life time 續航時間	About 60 minutes 約60分鐘
Size 尺寸	36.5 * 42 * 233.7mm
Weight 重量	160g

### Instructions

Click the power button to turn on antivirus, swipe back and forth at the item 5-10 times, click the button for the second time to close

**Warning: Do not irradiate eyes and skin**

單擊開關鍵開啟殺毒, 對著物品來回掃動5-10次, 第二次單擊按鍵關閉

**警告: 禁止照射眼睛和皮膚**

# Portable LED UVC Sterilizing Lamp

## 便攜式手持LED UVC殺毒燈

Model: CAH

### Features:

- Light and compact, portable
- One key disinfection, simple operation, fast anti-virus rate of 99.9% in 10 seconds, and the working time is 5 minutes, and the power is automatically cut off
- The product has gravity induction, and the lamp is turned off in reverse direction. When the lamp bead is more than 90° upward, the lamp bead goes out and stops working, and starts working when it goes down again
- It is suitable for disinfection and sterilization of cosmetics, keys, jewelry, watches, etc
- 輕便小巧, 便攜隨行
- 一鍵消毒, 操作簡單, 10s快速殺毒, 殺毒率高達99.9%, 工作時長5分鐘自斷電
- 產品具有重力感應, 反向熄燈, 燈珠向上 >90° 時, 燈珠熄滅停止工作, 再次向下時開始工作
- 適用於美妝用品, 鑰匙, 首飾, 手錶等物品消毒殺菌

### Specifications

Product Model 產品型號	CAH
Product Function 產品功能	Sterilization disinfection 殺菌消毒
Material 材質	ABS
Charging time 充電時間	1 H
Wavelength 波長	260~275nm
Working time 工作時間	5 minutes (self-power off) 5分鐘(自斷電)
Battery capacity 電池容量	400mA
Operation mode 操作方式	Button type 按鍵式
Disinfection time 消毒時間	10 ~ 300s
Size 尺寸	125 * 30 * 15 mm
Weight 重量	33g

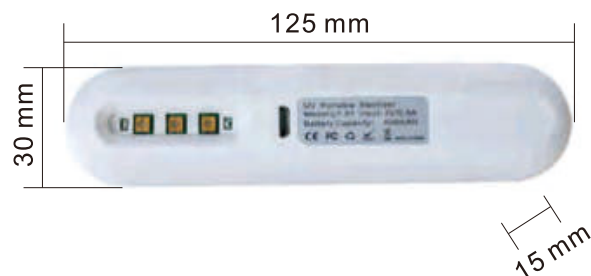

### Instructions

The distance from UVC lamp downward to disinfect articles is 15 ~ 20 mm. Long down start key for 2 s, 10 ~ 300 seconds can complete disinfection and sterilization. The product has gravity induction design, tilt > 90° and automatically turn off ultraviolet light. It is powered off after 5 minutes,

**Warning:** 1) it is forbidden to irradiate human skin and eyes or other animals with ultraviolet lamp. 2) When holding the disinfection lamp, hold the two sides of the product with your fingers. Do not hold the product in the palm to prevent UV damage to the finger skin.

將UVC燈朝下距離需消毒物品15~20mm, 長下啟動鍵2s 開啟, 10~300秒可完成消毒殺菌工作, 產品具有重力感應設計, 傾斜>90°, 自動閉紫外光再次長按啟動鍵2s關閉。開啟5分鐘後自斷電, 警告: 1) 禁止用紫外線燈照射人體皮膚和眼睛或其他動物。2) 手持消毒燈時, 用手指拿捏產品兩側, 不可將產品握於掌心, 防止紫外線對手指皮膚造成損傷。



# Portable LED UVC Sterilizing Lamp

## 便攜式手持LED UVC殺毒燈

Model: CAI

### Features:

- UVC-LED anti-virus technology, three deep UV LED lamp beads, the service life of up to 100000 hours, long-term escort, 10 seconds rapid virus killing rate as high as 99.9%;
- One key disinfection, simple operation, light and compact, portable and accompanying;
- The product has gravity induction, and the lamp is turned off in reverse direction. When the lamp bead is more than 90 ° upward, the lamp bead goes out and stops working, and starts working when it goes down again
- Universal USB charging port, adapter and mobile power supply
- It is suitable for disinfection and sterilization of cosmetics, keys, jewelry, watches, etc
- UVC-LED殺毒技術, 3顆深紫外LED燈珠, 壽命長達10萬小時, 長久保駕護航, 10s快速殺毒殺毒率高達99.9%;
- 一鍵消毒, 操作簡單; 輕便小巧, 便攜隨行;
- 產品具有重力感應, 反向熄燈, 燈珠向上 >90° 時, 燈珠熄滅停止工作, 再次向下時開始工作
- 通用USB充電口, 適配器和移動電源供電
- 適用於: 美妝用品, 鑰匙, 首飾, 手錶等物品消毒殺菌

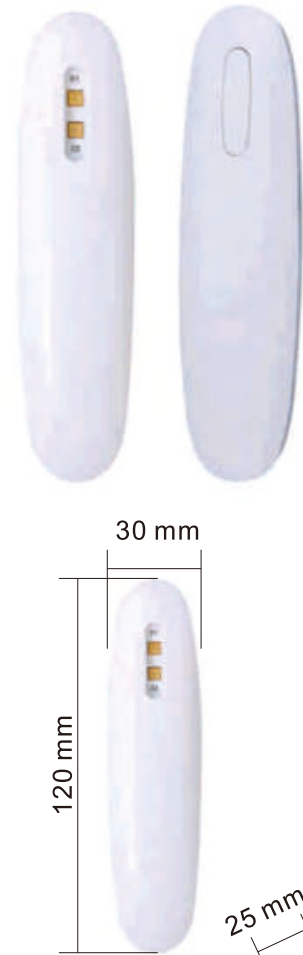

### Specifications

Product Model 產品型號	CAI
Product Function 產品功能	Sterilization disinfection 殺菌消毒
Product Material 產品材質	ABS
Voltage 電壓	5V
Power 功率	1.2W
Wavelength 波長	270-275nm
Battery capacity 電池容量	200mAH
Life time 續航時間	100 min
Size 尺寸	120 * 30 * 25mm
Weight 重量	33g

### Instructions

After opening. Move back and forth 2cm above the object. Complete within 300 seconds. Press again to close. It will automatically shut down if there is no operation within 5 minutes. Product with gravity sensing design

**Warning: 1) it is forbidden to irradiate human skin and eyes or other animals with ultraviolet lamp. 2) When holding the disinfection lamp, hold the two sides of the product with your fingers. Do not hold the product in the palm to prevent UV damage to the finger skin.**

長按啟動鍵3秒開機, 在距離物品上方2cm處來回移動, 10~300秒可完成消毒殺菌工作, 輕按鍵關機。開機5分鐘內沒有任何操作, 電源自動關閉。產品具有重力感應設計, 傾斜>90°, 自動關閉紫外光  
**警告: 1) 禁止用紫外線燈照射人體皮膚和眼睛或其他動物。2) 手持消毒燈時, 用手指拿捏產品兩側, 不可將產品握於掌心, 防止紫外線對手指皮膚造成損傷。**

# Portable LED UVC Sterilizing Lamp

## 可攜式手持LED UVC殺毒燈

Model: CAJ

### Features:

- Lightweight, compact, and portable;
- UVC-LED antivirus technology, 10s rapid antivirus and antivirus rate as high as 99.9%;
- Long press 3 seconds to start, one key disinfection, simple operation;
- Universal USB charging port, adapter and mobile power supply
- It is suitable for disinfection and sterilization of cosmetics, keys, jewelry, watches, etc
- 輕便小巧, 便攜隨行;
- UVC-LED殺毒技術, 10s快速殺毒殺毒率高達99.9%;
- 長按3秒啟動, 一鍵消毒, 操作簡單;
- 通用USB充電口, 適配器和移動電源供電
- 適用於: 美妝用品, 鑰匙, 首飾, 手錶等物品消毒殺菌



### Specifications

Product Model 產品型號	CAJ
Product Function 產品功能	Sterilization disinfection 殺菌消毒
Working voltage 工作電壓	3.7V
Current 電流	1 (A)
Wavelength 波長	260~275nm
Life time 續航時間	8 h
Battery capacity 電池容量	500mAh
Operation mode 操作方式	Button type 按鍵式
Disinfection time 消毒時間	10 ~ 300s
Size 尺寸	123 * 30 * 20 mm
Weight 重量	33g

### Instructions

Press and hold the switch button for 3 seconds, and the "tick" sound will turn on, and the work indicator light will be on. Aim the UV lamp bead on the sterilized articles, move the items to be sterilized slowly from 3 to 5 cm, and keep the same area for 5-10 seconds. After completion, click close, and the blue indicator light should go out.

**Warning: do not expose eyes and skin**

長按開關按鈕3秒, “滴”聲響即開機, 工作指示燈亮起, 開始滅菌, 將紫外燈珠對準待滅菌物品, 保持垂直距離3-5cm; 緩慢移動待滅菌物品, 同一區域保持5-10秒, 完成後關閉開關, 藍色指示燈應熄滅。

**警告: 禁止照射眼睛和皮膚**

# Portable LED UVC Disinfection Stick

## 便攜手持式紫外線消毒棒

Model: CBQ

### Features:

- UVC-LED anti-virus technology, the disinfection lamp is composed of 3 UVC-LED and 2 UV compensation lamps, with a wide disinfection range
- One button disinfection, easy to operate, 10s rapid antivirus, the antivirus rate is up to 99.9%, and the working time is 15 minutes, self powered off
- Built in gravity sensing, the light turns off automatically when turning  $\geq 90^\circ$ , so as to avoid exposure to skin and eyes;
- It is applicable to disinfection and sterilization of cosmetics, keys, jewelry, watches, etc
- UVC-LED殺毒技術, 消毒燈由3顆 UVC-LED和2顆UV補償燈組成, 消毒範圍大
- 一鍵消毒, 操作簡單, 10s快速殺毒, 殺毒率高達99.9%, 工作時長15分鐘自斷電
- 內置重力感應, 翻轉 $\geq 90^\circ$ 燈光自動關閉, 避免照射到皮膚和眼睛;
- 適用於美妝用品, 鑰匙, 首飾, 手錶等物品消毒殺菌



### Specifications

Product Model 產品型號	CBQ
Product Function 產品功能	Sterilization disinfection 殺菌消毒
Product Material 產品材質	ABS
Voltage 電壓	5V-1A
Power 功率	1.5W
Wavelength 波長	260-285nm
Battery capacity 電池容量	750MAH
Life time 續航時間	100 min
Size 尺寸	145*35*20mm
Weight 重量	39g

### Instructions

After opening. Move back and forth 2cm above the object. Complete within 300 seconds. Press again to close. It will automatically shut down if there is no operation within 5 minutes. Product with gravity sensing design

**Warning: 1) it is forbidden to irradiate human skin and eyes or other animals with ultraviolet lamp. 2) When holding the disinfection lamp, hold the two sides of the product with your fingers. Do not hold the product in the palm to prevent UV damage to the finger skin.**

長按啟動鍵3秒開機, 在距離物品上方2cm處來回移動, 10~300秒可完成消毒殺菌工作, 輕按鍵關機。開機5分鐘內沒有任何操作, 電源自動關閉。產品具有重力感應設計, 傾斜 $>90^\circ$ , 自動關閉紫外光  
**警告: 1) 禁止用紫外線燈照射人體皮膚和眼睛或其他動物。2) 手持消毒燈時, 用手指拿捏產品兩側, 不可將產品握於掌心, 防止紫外線對手指皮膚造成損傷。**

# MINI LED UVC Sterilizing Lamp(Side Glow)

## 迷你紫外線消毒燈(側面發光)

Model: CBP

### Features:

- Ultraviolet UVC disinfection method is adopted, with long irradiation distance, strong sterilization effect, and bacteria removal rate>99.9%
- Intelligent human induction, instant sterilization, mini lightweight design
- USB plug-in
- 採用紫外線UVC消毒方式, 照射距離遠, 殺菌效果強, 細菌去除率>99.9%
- 智能人體感應, 即時即刻滅菌, 迷你輕巧設計
- USB插電使用



### Specifications

Product Model 產品型號	CBP
Product Function 產品功能	Sterilization disinfection 殺菌消毒
Material 材質	ABS外殼+金屬殼
Working voltage 工作電壓	5V
Current 電流	0.2A
Wavelength 波長	270-280nm
Length Of Charging Line 充電線長度	1M
Size 尺寸	60*20*15mm
Weight 重量	22g

### Instructions

Connect the product and the USB Type-c charging cable to the 5V-1A charger or the computer USB connector

**Warning: do not expose eyes and skin**

1. 將感應頭對向人體出現方向, 紫光燈對準所需照射區域(最佳距離為20-30cm), 粘貼固定。
  2. 插入5V USB適配器, (可使用延長USB線)
  3. 人體出現時啟動設備, 感應頭紅燈閃爍, UVC及氣氛燈關閉。
  4. 人體離開時啟動紫外線工作, 感應頭綠燈閃爍, UVC及氣氛燈長亮10分鐘。
  5. 完成工作後, 感應頭為綠色常亮進入特機狀態
- 警告: 禁止照射眼睛和皮膚**

# Multifunctional Intelligent Ultraviolet Germicidal Lamp

## 多功能智能紫外线杀菌灯

Model: CZ

### Features:

- UVC / UVA dual-wave sterilization, sterilization rate > 99.9%
- Intelligent protection: when people stop disinfecting, they will automatically disinfect after leaving
- Wardrobe lighting, with human body induction function, automatic lighting when people come, and automatic shutdown when people walk
- Ultra-thin design, side-emitting design, customized side-emitting light guide plate luminous paper, uniform luminescence.
- It is suitable for disinfection of family wardrobe, shoe cabinet, bed, underwear, carry on items, baby products, automobiles, etc.
- UVC / UVA 雙波殺菌, 殺菌率 > 99.9%
- 智能防護: 人們停止消毒時, 離開後會自動消毒
- 衣櫃照明, 帶人體感應功能, 人來自動照明, 人走自動關閉
- 採用超薄設計, 側發光設計, 定制的側發光導光板發光紙, 發光均勻
- 適用於家庭衣櫃, 鞋櫃, 床, 內衣, 隨身物品, 嬰兒用品, 汽車等的消毒



### Specifications

Product Model 產品型號	CZ
Product Function 產品功能	Sterilization disinfection 殺菌消毒
Power: 功率	1 W
Standby current 待機電流	0.7mA
Charging interface 充電接口	TYPE-C
Wavelength 波長	UVC (270-280nm) +UVA (395-405nm)
Power supply 電源供應	Polymer lithium ion battery 3.7V/1.8Ah 聚合物鋰離子電池 3.7V/1.8Ah
Sensing distance 感應距離	1-2m
Size 尺寸	405 * 40 * 9.8mm
Weight 重量	190g

### Instructions

When the light is off, press and hold for 1.5 seconds, the first light is on for 5 seconds, and it enters the human body induction state (not controlled by light control). During the sterilization process, when a person comes, the UVC lamp will go out; when no one is working for 15 minutes, the UVC lamp will go out. When the person leaves, the delay is 30 seconds, and the UVC lamp works again for 15 minutes.

**Warning: Do not irradiate eyes and skin**

关灯状态下, 长按1.5秒, 首亮5秒, 进入人体感应状态(不受光控控制), 杀菌过程中, 人来, UVC灯灭; 无人时连续工作15分钟, UVC灯灭。人离开时, 延时30秒, UVC灯重新工作15分钟。

**警告: 禁止照射眼睛和皮膚**

---

# Mercury Lamp, Ozone Series

汞燈、臭氧殺菌消毒燈系列

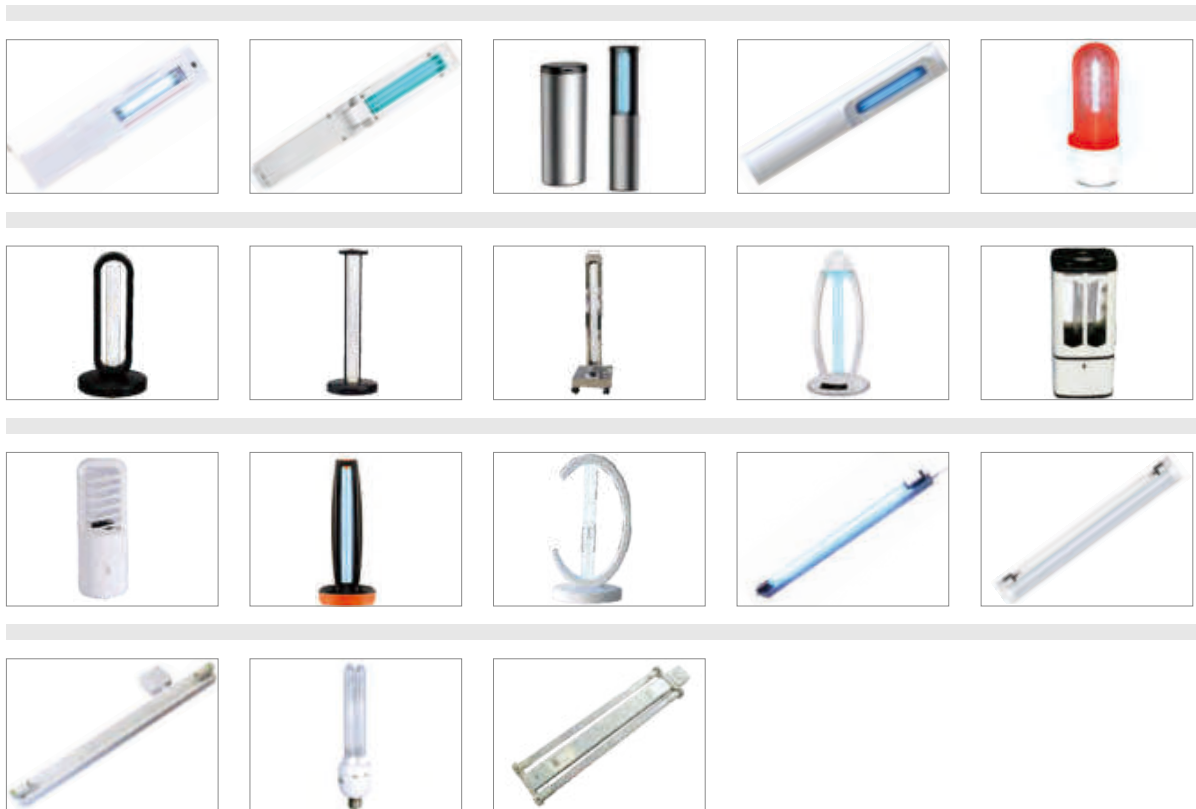



## UV Anti-virus Lamp (Mercury Lamp Type)

### 紫外線殺毒燈 (汞燈)

Model: CAK

#### Features:

- Ultraviolet disinfection lamp, the sterilization rate is 99.9%
- The product has gravity induction, reverse light off, when the lamp tube upward > 90 degrees, the lamp goes out and stops working, and starts to work when it goes down again
- Suitable for sterilization of household wardrobes, shoe cabinets, beds, underwear, personal belongings, baby products, cars, etc.
- 紫外線消毒燈，殺菌率99.9%
- 產品具有重力感應，反向熄燈，燈管向上 >90° 時，燈管熄滅停止工作，再次向下時開始工作
- 適用於家用衣櫃，鞋櫃，床，內衣，隨身物品，嬰兒用品，汽車等殺菌

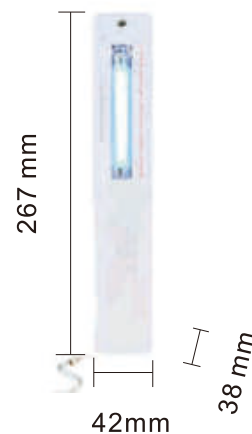

#### Specifications

Product Model 產品型號	CAK
Product Function 產品功能	Sterilization disinfection 殺菌消毒
Product Material 產品材質	ABS
Power 功率	3W
Wavelength 波長	260-280nm
Lamp 燈	Mercury lamp 汞燈
Power supply 電源供應	Takes four AA batteries 四節AA電池
Disinfection time 消毒時間	1-3 min
Level Of Protection 防護等級	IP55
Size 尺寸	267 * 38 * 42mm
Weight 重量	136g

#### Instructions

Click the button to turn on the antivirus after the beep sounds, swipe slowly at the object for 10 seconds, click the button for the second time to close

**Warning: Do not irradiate eyes and skin**

單擊開關鍵嗚聲響起後開啟殺毒，對著物品慢慢扫动10秒，第二次單擊按鍵關閉

**警告：禁止照射眼睛和皮膚**

# Folding UV Antivirus Lamp

## 折疊式紫外線殺毒燈

Model: CAL

### Features:

- Sterilization rate reaches 99.9%;
- Micro-instant sterilization, high efficiency and energy saving; small size, easy to carry;
- The product has gravity induction, reverse light off, when the lamp tube upward > 90 degrees, the lamp goes out and stops working, and starts to work when it goes down again
- UV UVC with high precision and special wavelength is used to sterilize and disinfect the surface of objects;
- Suitable for: disinfection of personal belongings, etc
- 殺菌率達到99.9%;
- 微瞬間殺菌, 高效節能; 體積小, 便於攜帶;
- 產品具有重力感應, 反向熄燈, 燈管向上 >90° 時, 燈管熄滅停止工作, 再次向下時開始工作
- 具有高精度和特殊波長的UV UVC用於對物品的表面進行滅菌和消毒;
- 適用於: 美妝用品, 鑰匙, 首飾, 手錶等物品消毒殺菌

### Specifications

Product Model 產品型號	CAL
Product Function 產品功能	Sterilization disinfection 殺菌消毒
Product Material 產品材質	ABS
Power supply 電源供應	AAA battery / USB power supply AAA電池/ USB電源
Power 功率	2W
Wavelength 波長	200-254nm
Suitable angle 適用角度	160°
Lamp 燈	Quartz glass tube 石英玻璃管
Size 尺寸	125 * 38 * 25mm (closed cover) 閉合 240 * 38 * 25mm (unfolded) 展開
Weight 重量	150g



### Instructions

Turn on the product, click the power switch, the indicator light is on to indicate that the power is on, move slowly towards the object and irradiate it for more than 30 seconds, click the button to turn off

**Warning: 1. It is forbidden to irradiate the eyes and skin; 2. The battery and USB cannot be used at the same time; 3. USB cannot be used to charge the battery**

打開產品, 按一下電源開關, 指示燈亮表示電源接通, 對著物品慢慢移動照射30秒以上, 按一下按鍵關閉

**警告: 1、禁止照射眼睛和皮膚; 2、電池和USB不能同時使用; 3、USB不能用來給電池充電**

# Telescopic VU Disinfection Lamp

## 伸縮式UVC紫外線消毒燈

Model: BR

### Features:

- One-second telescopic operation is convenient, light and portable without taking up space
- Universal USB charging port, adapter and mobile power supply
- It can be turned on after 3 seconds by pressing the power button, the ultraviolet light is on (gravity sensor, automatically turns off when  $>90^\circ$ ), the antivirus rate is as high as 99.9%
- Suitable for disinfection of household wardrobes, shoe cabinets, beds, underwear, personal belongings, baby products, cars, etc.
- 一秒伸縮操作便捷, 輕便攜帶不占空間
- 通用USB充電口, 適配器和移動電源供電
- 按下開機鍵3秒後可以開機, 紫外線燈亮(重力感應,  $>90^\circ$ 時自動關閉), 殺毒率高達99.9%
- 適用於家庭衣櫃、鞋櫃、床、內衣、隨身物品、嬰兒用品、汽車等的消毒

### Specifications

Product Model 產品型號	BR
Product Function 產品功能	Sterilization disinfection 殺菌消毒
Product Material 產品材質	ABS
Voltage 電壓	5V
Power 功率	3W
Wavelength 波長	253.7nm
Battery capacity 電池容量	500mAH
Life time 續航時間	about 60 minutes 約60分鐘
Size 尺寸	150 * 35 * 19mm
Weight 重量	80g

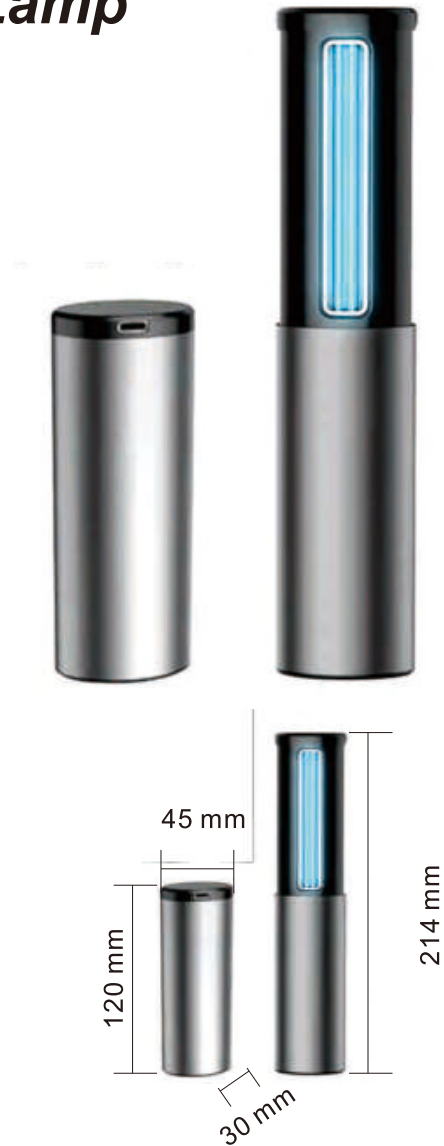

### Instructions

Press and hold the power on key for 2 seconds, the UV lamp will be on (gravity sensor, it will be automatically turned off when it is more than  $90^\circ$ ), and the light will be on and the shutdown will be off. Irradiate the object back and forth for 3 seconds to 2 minutes. Press once more to turn off the device. The lamp will be on continuously for more than 2 minutes without shutting down.

**Warning: Do not irradiate eyes and skin**

長按開機鍵2秒後開機, 紫外線燈亮(重力感應,  $>90^\circ$ 時自動關閉), 開機後燈著亮, 關機滅。對著物品來回掃射且應達到3秒到2分鐘, 中途再短按一次關機。不關機情況下, 燈一直亮超過2分鐘後自動熄滅。

**警告: 禁止照射眼睛和皮膚**

# Portable UVC Wand Sterilize

## 便攜式紫外線UVC棒式滅菌器

Model: CE

### Features:

- UVC-LED anti-virus technology, three deep UV LED lamp beads, the service life of up to 100000 hours, long-term escort, 10 seconds rapid virus killing rate as high as 99.9%;
- One key disinfection, simple operation, light and compact, portable and accompanying;
- The product has gravity induction, reverse light off, when the lamp tube upward > 90 degrees, the lamp goes out and stops working, and starts to work when it goes down again
- Universal USB charging port, adapter and mobile power supply
- It is suitable for disinfection and sterilization of cosmetics, keys, jewelry, watches, etc
- UVC-LED殺毒技術, 3顆深紫外LED燈珠, 壽命長達10萬小時, 長久保駕護航, 10s快速殺毒殺毒率高達99.9%;
- 一鍵消毒, 操作簡單; 輕便小巧, 便攜隨行;
- 產品具有重力感應, 反向熄燈, 燈管向上 >90° 時, 燈管熄滅停止工作, 再次向下時開始工作
- 通用USB充電口, 適配器和移動電源供電
- 適用於: 美妝用品, 鑰匙, 首飾, 手錶等物品消毒殺菌

### Specifications

Product Model 產品型號	CE
Product Function 產品功能	Sterilization disinfection 殺菌消毒
Product Material 產品材質	ABS
Input specifications 輸入規格	5V 1.5A
Power 功率	5W
Wavelength 波長	185-253.7nm
Charging time 充電時間	about 90 minutes 約90分鐘
Disinfection time 消毒時間	1-3 min
Size 尺寸	31 * 31 * 200 mm
Weight 重量	75g

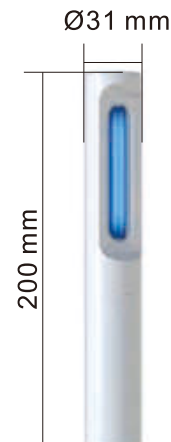

### Instructions

Click on the on key to turn on the anti-virus, move slowly about 2cm above the object to irradiate. After 30 ~ 300 seconds, the disinfection and sterilization can be completed. Click the button again to close

**Warning: do not expose eyes and skin**

單擊開關鍵開啟殺毒, 在距離物品上方2cm左右慢慢移動照射, 30~300秒後可完成消毒殺菌工作第二次單擊按鍵關閉

**警告: 禁止照射眼睛和皮膚**

# UV Anti-virus Lamp

## 紫外線殺毒燈

Model: BB

### Features:

- Avoid the shortcomings of direct ultraviolet radiation, really achieve 360 degrees no dead Angle sterilization and deodorization
- Use quartz lamp, high transmission, long service life, it is the best material for UV lamp
- Suitable for household wardrobe, shoe cabinet, bed, underwear, carry-on items, baby supplies, car and other sterilization
- 避免直接紫外線輻射的缺點,真正實現360度無死角殺菌除臭
- 使用石英燈,透光率高,使用壽命長,是紫外線燈的最佳材料
- 適用於家用衣櫃,鞋櫃,床,內衣,隨身物品,嬰兒用品,汽車等殺菌

### Specifications

Product Model 產品型號	BB
Product Function 產品功能	UV+ozone double sterilization disinfection UV+臭氧雙重殺菌消毒
Product Material 產品材質	ABS+ iron mesh ABS+鐵網
Tube 管子	Quartz tube
Power 功率	2.5W
Wavelength 波長	185nm + Ozone
Voltage 電壓	3.7V/500mA
Battery 電池	600mAH;
Charging time 充電時間	1-2 H
Timing 定時	Once each half hour 半小時一次
Size 尺寸	156 * 57 mm
Weight 重量	150g



### Instructions

Press the bottom button to turn on, there will be audible and visual prompts (green light flashes, buzzer beeps), and the UV light will be on for about 10 seconds. When the UV lamp is turned on, press the button at the bottom to turn off the UV lamp. If it is not pressed for 30 minutes, it will automatically shut down.

**Warning: When opening, it is forbidden for people, animals and plants to be on site to avoid long-term exposure of ultraviolet rays to skin and eyes**

按底部按鍵開機,開機後有聲光提示(綠燈閃爍,蜂鳴器發出滴滴報警聲),10s左右UV燈亮起。當UV燈開啟後,按底部按鍵,UV燈關閉,如果不按30min後自動關機。

**警告:開啟時禁止人和動、植物在現場,避免紫外線長時間照射皮膚和眼睛**

# UV Anti-virus Lamp (Oval)

## 紫外線殺菌臺燈 (黑色橢圓款)

Model: BI

### Features:

- UV + ozone double sterilization can cover the blind spots that cannot be irradiated;
- The replacement operation is simple; the three-dimensional design of the lampshade increases the luminous surface;
- Multi-function remote control, 360 degree zone remote control is more convenient;
- Suitable for sterilization and deodorization of families, kindergartens, hospitals, restaurants, offices, etc.;
- UV + 臭氧雙重殺菌可以覆蓋無法照射的死角;
- 更換操作簡單;燈罩三維設計,增加了發光面;
- 多功能遙控器,360度分區遙控器更方便;
- 適用於家庭,幼兒園,醫院,飯店,辦公室等的殺菌除臭;



### Specifications

Product Model 產品型號	BI
Product Function 產品功能	Sterilization disinfection 殺菌消毒
Product Material 產品材質	ABS
Rated voltage 額定電壓	110V
Power 功率	38W
Frequency 頻率	50Hz
Wavelength 波長	185nm UV + Ozone 185nmUV+臭氧
Service life 使用壽命	10000h
Timing mode 計時模式	Three gear design, 三檔設計 AI intelligent timing AI智能計時
Size 尺寸	200 * 110 * 400mm
Weight 重量	1000g

### Instructions

Press the required timing time button, the LED indicator of the control power box will flash 20 times, after a delay of 20 seconds, the power-on lamp will automatically shut down after the scheduled time, press the start button again to pause

**Warning: When opening, it is forbidden for people, animals and plants to be on site to avoid long-term exposure of ultraviolet rays to skin and eyes**

按下需要定時時間鍵,控制電源盒LED指示燈閃20次,延時20秒後開機燈工作已定時時間後自動關機,再次按啟動鍵可暫停  
**警告:開啟時禁止人和動、植物在現場,避免紫外線長時間照射皮膚和眼睛**

# UV Anti-virus Lamp

## 紫外線殺菌臺燈 (黑色)

Model:BJ

### Features:

- UV + ozone double sterilization can cover the blind spots that cannot be irradiated;
- The three-dimensional design of the lampshade adds a luminous surface;
- Multi-function remote control, 360 degree zone remote control is more convenient;
- Suitable for sterilization and deodorization of families, kindergartens, hospitals, restaurants, offices, etc.;
- UV + 臭氧雙重殺菌可以覆蓋無法照射的死角;
- 燈罩的三維設計,增加了發光面;
- 多功能遙控器,360度分區遙控器更方便;
- 適用於家庭,幼兒園,醫院,飯店,辦公室等的殺菌除臭;

### Specifications

Product Model 產品型號	BJ
Product Function 產品功能	Sterilization disinfection 殺菌消毒
Product Material 產品材質	ABS + aluminum alloy cylinder ABS + 鋁合金圓柱體
Rated voltage 額定電壓	220V / 110V
Power 功率	65W
Wavelength 波長	185nm UV + Ozone 185nm UV+臭氧
Service life 使用壽命	10000h
Timing mode 計時模式	20m through wall remote control + timing 20m穿牆遙控器+定時
Size 尺寸	200 * 140 * 550mm
Weight 重量	1500g



### Instructions

Click the power button to start, the default disinfection time is 15 minutes. Press the button to select the time, the light will light up after 30 seconds. After the timer expires, it will automatically turn off.

**Warning: When opening, it is forbidden for people, animals and plants to be on site to avoid long-term exposure of ultraviolet rays to skin and eyes**

單擊電源按鈕啟動, 默認消毒時間15分鐘。按下按鈕選擇時間, 30秒後燈會亮起。計時器結束後, 將自動關閉。

**警告: 開啟時禁止人和動、植物在現場, 避免紫外線長時間照射皮膚和眼睛**



# UV Anti-virus Lamp

## 紫外線殺毒燈

Model: BF

### Features:

- Using ultraviolet + ozone double sterilization, blind corners can also penetrate
  - There is a bulb replacement position on the top, it is easy to replace the bulb
  - Three-dimensional lampshade design, anti-collision and anti-fall, increase the luminous surface
  - Multi-function remote control, 360-degree zone remote control is more convenient
  - Suitable for sterilization and deodorization of families, kindergartens, hospitals, restaurants, offices, etc.
- 採用紫外線+臭氧雙重殺菌, 盲角也可穿透
  - 頂部有燈泡替換位置, 替換燈泡簡單
  - 燈罩三維設計, 防撞防摔, 增加發光面
  - 多功能遙控器, 360度分區遙控器更方便
  - 適用於家庭, 幼兒園, 醫院, 飯店, 辦公室等的殺菌除臭

### Specifications

Product Model 產品型號	BF
Product Function 產品功能	Sterilization disinfection 殺菌消毒
Product Material 產品材質	201 stainless steel 201不銹鋼
Rated voltage 額定電壓	220V
Current 現時	0.195a
Power 功率	150W
Frequency 頻率	50Hz
Wavelength 波長	185nm UV + Ozone 185nm UV+臭氧
Service life 使用壽命	10000h
Timing mode 計時模式	Mechanical knob timing 機械旋鈕定時 0-60min timing optional 0-60分鐘計時可選
Size 尺寸	250 * 250 * 900mm
Weight 重量	3500g



### Instructions

Press the required timing time button, the LED indicator of the control power box will flash 20 times, after a delay of 20 seconds, the power-on lamp will automatically shut down after the scheduled time, press the start button again to pause

**Warning: When opening, it is forbidden for people, animals and plants to be on site to avoid long-term exposure of ultraviolet rays to skin and eyes**

按下需要定時時間鍵, 控制電源盒LED指示燈閃20次, 延時20秒後開機燈工作已定時時間後自動關機, 再次按啟動鍵可暫停

**警告: 開啟時禁止人和動、植物在現場, 避免紫外線長時間照射皮膚和眼睛**



## UV Anti-virus Lamp (Big White)

### 紫外線殺毒燈

Model: BK

#### Features:

- UV + ozone double sterilization can cover blind spots that cannot be irradiated;
- The three-dimensional design of the lampshade has a new light-emitting surface; the operation of replacing the bulb is simple;
- Double tube focusing, 360 degree sterilization;
- Suitable for sterilization and deodorization in families, kindergartens, hospitals, restaurants, offices, etc.;
- UV + 臭氧雙重殺菌可以覆蓋無法照射的死角;
- 燈罩的三維設計, 新增了發光面; 更換燈泡操作簡單;
- 雙管聚焦, 360度殺菌;
- 適用於家庭, 幼兒園, 醫院, 飯店, 辦公室等的殺菌除臭;

#### Specifications

Product Model 產品型號	BK
Product Function 產品功能	Sterilization disinfection 殺菌消毒
Product Material 產品材質	ABS + aluminum shell ABS + 鋁殼
Rated voltage 額定電壓	220V / 50Hz
Power 功率	38W
Wavelength 波長	254nm UV + Ozone 254nm UV+臭氧
Service life 使用壽命	10000h
Timing mode 計時模式	Remote control + timing 遙控器+定時 Applicable area: 40m <sup>2</sup> 適用面積: 40m <sup>2</sup>
Size 尺寸	210*110*460mm
Weight 重量	1000g

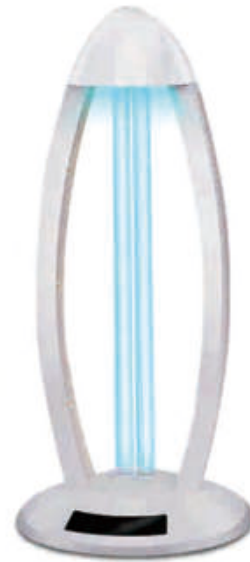

#### Instructions

When the button is pressed, the indicator light flashes to turn on the sterilization, and it will automatically turn off when the time is up, without manual switch

**Warning: When opening, it is forbidden for people, animals and plants to be on site to avoid long-term exposure of ultraviolet rays to skin and eyes**

按下按鈕後指示燈閃爍開啟滅菌, 時間到後自動關閉無須手動開關

**警告: 開啟時禁止人和動、植物在現場, 避免紫外線長時間照射皮膚和眼睛**

# Portable UV Anti-virus Lamp

## 便捷式紫外線殺菌燈

Model: CAM

### Features:

- 30 minutes full disinfection; 28s delay start;
- High transparency quartz glass material, effective sterilization and purification environment;
- UV + ozone double sterilization, in-depth killing nuclear;
- Applicable places: wardrobe, cabinet, refrigerator, car, etc;
- 30分鐘完全消毒; 28s延遲啟動;
- 高透明石英玻璃材料, 有效的殺菌淨化環境;
- 紫外線+臭氧雙重殺菌, 深度殺核;
- 適用場所: 衣櫃, 櫥櫃, 冰箱, 汽車等;

### Specifications

Product Model 產品型號	CAM
Product Function 產品功能	Sterilization disinfection 殺菌消毒
Product Material 產品材質	ABS + quartz glass ABS + 石英玻璃
Rated voltage 額定電壓	5V
Lamp 燈	U-type quartz lamp U型石英燈
Power 功率	2.5W
Applicable area 適用範圍	3-5m <sup>2</sup>
Wavelength 波長	254nm UV + Ozone 254nm UV+臭氧
Service life 使用壽命	8000h
Power supply 電源供應	USB charging, switch power on for 3 seconds USB充電, 開啟電源3秒鐘
Size 尺寸	50 * 50 * 120mm
Weight 重量	400g



### Instructions

Long press the power button for 3 seconds, the light will turn on after a delay of 28 seconds. The germicidal lamp will automatically go out after 30 minutes of lighting

**Warning: When opening, it is forbidden to keep people, animals and plants on site to avoid long-term exposure of ultraviolet rays to skin and eyes**

長按開關鍵3秒, 延時28秒後亮燈。亮燈30分鐘後殺菌燈便自動熄滅

**警告: 開啟時禁止人和動、植物在現場, 避免紫外線長時間照射皮膚和眼睛**

# UV Anti-virus Lamp

## 紫外線殺毒燈

Model: CAN

### Features:

- 30 minutes full disinfection; 28s delay start;
  - High transparency quartz glass material, effective sterilization and purification environment;
  - Small size, easy to carry out;
  - Applicable places: wardrobe, cabinet, refrigerator, car, etc;
- 
- 30分鐘完全消毒；28s延遲啟動；
  - 高透明石英玻璃材料，有效的殺菌淨化環境；
  - 體積小，便於攜帶；
  - 適用場所：衣櫃，櫥櫃，冰箱，汽車等；

### Specifications

Product Model 產品型號	CAN
Product Function 產品功能	Sterilization disinfection 殺菌消毒
Product Material 產品材質	ABS
Rated voltage 額定電壓	5V
Power 功率	3.8W
Lamp 燈	Quartz glass tube 石英玻璃管
Service life 使用壽命	10000h
Power supply 電源供應	AAA battery / USB power supply AAA電池/ USB電源
Size 尺寸	56 * 46.5 * 165mm
Weight 重量	100g

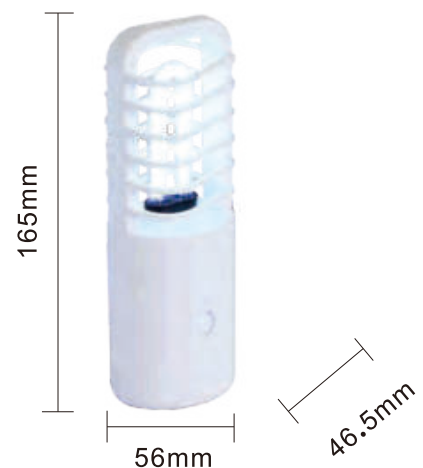

### Instructions

Long press the power button for 3 seconds, the light will turn on after a delay of 28 seconds. The delay indicator light flashes in blue. After 28 seconds, it lights up normally to start antivirus. After 30 minutes of light on, the germicidal lamp will automatically go out.

**Warning: When opening, it is forbidden to keep people, animals and plants on site to avoid long-term exposure of ultraviolet rays to skin and eyes**

長按開關鍵3秒，延時28秒後亮燈。延時指示燈為藍光閃爍，28秒後正常亮燈開始殺毒，亮燈30分鐘後殺菌燈便自動熄滅

**警告：開啟時禁止人和動、植物在現場，避免紫外線長時間照射皮膚和眼睛**

# UV Anti-virus Lamp

## 紫外線殺毒燈

Model: AU

### Features:

- UV + ozone double sterilization can cover the blind spots that cannot be irradiated;
- The three-dimensional design of the lampshade adds a luminous surface; the operation of replacing the bulb is very simple;
- Multi-function remote control, 360 degree zone remote control is more convenient;
- Suitable for sterilization and deodorization of families, kindergartens, hospitals, restaurants, offices, etc.;
- UV + 臭氧雙重殺菌可以覆蓋無法照射的死角;
- 燈罩的三維設計, 增加了發光面; 更換燈泡的操作很簡單;
- 多功能遙控器, 360度分區遙控器更方便;
- 適用於家庭, 幼兒園, 醫院, 飯店, 辦公室等的殺菌除臭;

### Specifications

Product Model 產品型號	AU
Product Function 產品功能	Sterilization disinfection 殺菌消毒
Product Material 產品材質	ABS
Rated voltage 額定電壓	220V
Lamp 燈	Quartz glass tube 石英玻璃管
Power 功率	38W
Use area 使用面積	10-40 m <sup>2</sup>
Wavelength 波長	254nm UV + Ozone 254nm紫外線+臭氧
Service life 使用壽命	10000h
Timing mode 計時模式	Three gear design 三檔設計 AI intelligent timing AI智能計時
Size 尺寸	425 * 160mm
Weight 重量	850g



### Instructions

Remote control pairing; after pressing the button, the indicator light flashes for 15, 30, 60 seconds to turn on the sterilization, and automatically turns off when the time is up.

**Warning: It is forbidden for people, animals and plants to be on site when opening, to avoid long-term exposure of ultraviolet rays to the skin and eyes**

遙控配對; 按下按鈕後指示燈閃爍15、30、60秒開啟滅菌, 時間到後自動關閉。

**警告: 開啟時禁止人和動、植物在現場, 避免紫外線長時間照射皮膚和眼**

# UV Anti-virus Lamp

## 紫外線殺毒燈

Model: AX

### Features:

- UV + ozone double sterilization can cover the blind spots that cannot be irradiated;
- The three-dimensional design of the lampshade adds a luminous surface; the operation of replacing the bulb is very simple;
- Multi-function remote control, 360 degree zone remote control is more convenient;
- Suitable for sterilization and deodorization of families, kindergartens, hospitals, restaurants, offices, etc.;
- UV + 臭氧雙重殺菌可以覆蓋無法照射的死角;
- 燈罩的三維設計, 增加了發光面; 更換燈泡的操作很簡單;
- 多功能遙控器, 360度分區遙控器更方便;
- 適用於家庭, 幼兒園, 醫院, 飯店, 辦公室等的殺菌除臭;

### Specifications

Product Model 產品型號	AX
Product Function 產品功能	Sterilization disinfection 殺菌消毒
Product Material 產品材質	ABS + iron chassis ABS + 鐵底盤
Rated voltage 額定電壓	220V
Power 功率	38W
Wavelength 波長	254nm UV + Ozone 254nm紫外線+臭氧
Service life 使用壽命	8000h
Control mode 控制方式	20m through wall remote control+3 gear timing 20m穿牆遙控器+3檔正時
Applicable area 適用範圍	20-40m <sup>2</sup>
Size 尺寸	200 * 140 * 410mm
Weight 重量	900g



### Instructions

Remote control pairing; after pressing the button, the indicator light flashes for 15, 30, 60 seconds to turn on the sterilization, and automatically turns off when the time is up.

**Warning: It is forbidden for people, animals and plants to be on site when opening, to avoid long-term exposure of ultraviolet rays to the skin and eyes**

遙控配對; 按下按鈕後指示燈閃爍15、30、60秒開啟滅菌, 時間到後自動關閉。

**警告: 開啟時禁止人和動、植物在現場, 避免紫外線長時間照射皮膚和眼**

# T8 UV Sterilized Bracket Lamp

## T8紫外線消毒支架燈

Model: C8

### Features:

- The UV light is 254nm wavelength and sterilized by UV;
- The sterilization rate of ultraviolet lamp was 99.9%;
- Ultraviolet rays destroy DNA and RNA of microorganisms, make them lose reproductive ability and die, and achieve the effect of disinfection and sterilization;
- It is suitable for disinfection of family wardrobe, shoe cabinet, bed, underwear, carry on items, baby products, etc.
- 紫外線波長為254nm, 並經紫外線消毒;
- 紫外線燈的殺菌率為99.9%;
- 紫外線會破壞微生物的DNA和RNA, 使其喪失生殖能力並死亡, 並達到消毒殺菌的效果;
- 適用於家庭衣櫃, 鞋櫃, 床, 內衣, 隨身物品, 嬰兒用品等的消毒



### Specifications

Product Model 產品型號	C8
Product Function 產品功能	Sterilization disinfection 殺菌消毒
Product Material 產品材質	0.3MM Spray-painting Aluminum housing, 2 Pin PC lamp holder 0.3MM噴漆鋁合金外殼, 2針PC燈座
Rated voltage 額定電壓	180-260V, 50/60 HZ
Lampholder 燈具支架	G13
Power 功率	15W, 20W, 30W, 36W
Wavelength 波長	254nm
Lifetime 壽命	30000H
PF	≥0.5
Size 尺寸	463*30*48mm 613*30*48mm 918*30*48mm 1223*30*48mm
Weight 重量	100g

### Instructions

Turn on when power on, turn off when power off

**Warning: People, animals and plants are forbidden to be on site when opening**

通電即開啟, 閉電即關閉

**警告: 開啟時禁止人和動、植物在現場**

# T5 UV Sterilized Bracket Lamp

## T5紫外線消毒支架燈

Model: C5

### Features:

- The UV light is 254nm wavelength and sterilized by UV;
- The sterilization rate of ultraviolet lamp was 99.9%;
- Ultraviolet rays destroy DNA and RNA of microorganisms, make them lose reproductive ability and die, and achieve the effect of disinfection and sterilization;
- Suitable for sterilization and deodorization of families, kindergartens, hospitals, restaurants, offices, etc.
- 紫外線波長為254nm, 並經紫外線消毒;
- 紫外線燈的殺菌率為99.9%;
- 紫外線會破壞微生物的DNA和RNA, 使其喪失生殖能力並死亡, 並達到消毒殺菌的效果;
- 適用於家庭, 幼兒園, 醫院, 飯店, 辦公室等的殺菌除臭

### Specifications

Product Model 產品型號	C5
Product Function 產品功能	Sterilization disinfection 殺菌消毒
Product Material 產品材質	0.3MM Spray-painting Aluminum housing, 2 Pin PC lamp holder 0.3MM噴漆鋁合金外殼, 2針PLC燈座
Rated voltage 額定電壓	180-260V, 50/60 HZ
Lampholder 燈具支架	G5
Power 功率	4W, 6W, 8W, 14W
Wavelength 波長	254nm
Lifetime 壽命	30000H
PF	≥0.5
Size 尺寸	159*23*35mm 235*23*35mm 311*23*35mm 572*23*35mm
Weight 重量	100g



### Instructions

Turn on when power on, turn off when power off

**Warning: People, animals and plants are forbidden to be on site when opening**

通電即開啟, 閉電即關閉

**警告: 開啟時禁止人和動、植物在現場**



# UVC Induction Germicidal Lamp + British Batten

## UVC感應殺菌燈+英式支架

**Model: CH**

### Features:

- Dedicated sensor for disinfection lamp: The sensor emits high-frequency electromagnetic waves (5.8GHz) and receives their echoes. When a change in the echo characteristics is detected, the microprocessor makes a judgment based on the characteristics of the echo change and triggers the "light on" Or turn off the lights". Signals can be detected through doors, glass panels and thin walls
- People come to suspend disinfection, and people restart anti-virus after leaving
- It is suitable for homes, factories, hospitals and other places that need disinfection and killing
- 消毒燈專用感應器:感應器發射高頻電磁波(5.8GHz)並接收他們的回波,當探測到回波特性有變化時,觸發“點燈或關燈”的指令,信號透過門,玻璃板及薄的牆壁,都有可能被探測到
- 人來暫停消毒,人走後自行重啟殺毒
- 適用於家庭,工廠,醫院,等需要消毒殺菌的場所



### Specifications

Product Model 產品型號	CH
Product Function 產品功能	Sterilization 殺菌
Voltage 電壓	AC220-240V
Power 功率	20W/40W
Lamp Base 燈腳	T8,G13
Wavelength 波長	253.7nm
Power Factor 功率因數	≥0.5
Preset Disinfection Time 預設消毒時間	30min
Delay Time 延遲時間	30s
Life Time 壽命	30000H
Size 尺寸	φ23*589mm (0.6m)

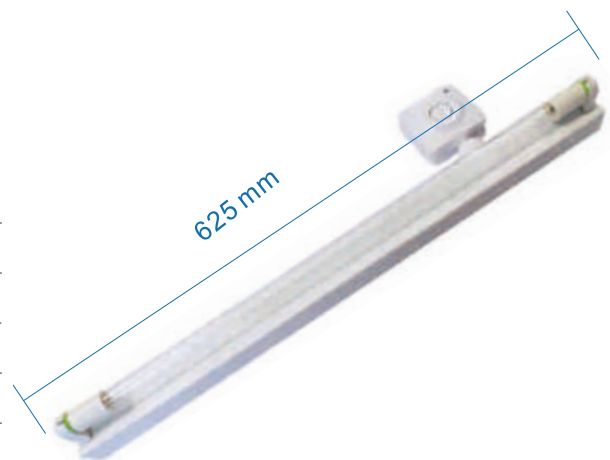



## E27 Screw Disinfection Lamp Ultraviolet

### E27螺口消毒燈紫外線

Model: CAO

#### Features:

- Integrated design, small size and easy to store
- Configure the wireless remote control through the wall, no need to add a wireless lamp holder controller
- High power, larger sterilization range
- Suitable for living room, bathroom, bedroom and other spaces
- 一體化設計, 體積小容易收納置放
- 配置無線穿牆遙控器, 不需要另外增加無線燈座控制器
- 大功率, 殺菌範圍更大
- 適合客廳、衛生間、臥室等空間



#### Specifications

Product Model 產品型號	CAO
Product Function 產品功能	Sterilization disinfection 殺菌消毒
Voltage 額定電壓	AC220V
Power 功率	38W
Lamp Holder 燈頭	E27
Wavelength 波長	253.7nm
Lifetime 壽命	20000H
Size 尺寸	278.3*63mm
Weight 重量	400g



# UVC Induction Germicidal Lamp + British Batten

## UVC感應殺菌燈+英式支架

Model: FE

### Features:

- Integrated design, small size and easy to store
- Configure the wireless remote control through the wall, no need to add a wireless lamp holder controller
- High power, larger sterilization range, suitable for living room, bathroom, bedroom and other spaces
- Suitable for sterilization and deodorization of families, kindergartens, hospitals, restaurants, offices, etc.
- 一體化設計，體積小容易收納置放
- 配置無線穿牆遙控器，不需要另外增加無線燈座控制器
- 大功率，殺菌範圍更大，適合客廳、衛生間、臥室等空間
- 適用於家庭，幼兒園，醫院，飯店，辦公室等的殺菌除臭



### Specifications

Product Model 產品型號	FE
Product Function 產品功能	Sterilization disinfection 殺菌消毒
Voltage 額定電壓	AC220V
Power 功率	9W+20W
Color Temp 色溫	4000K
Wavelength 波長	253.7nm
Lifetime 壽命	20000H
Size 尺寸	715*155*65mm
Weight 重量	1.15KG



# UVC Application Products

## UVC應用產品



# Household UV Antivirus Bag

## 家用紫外線殺毒包

Model: AD

### Features:

- The sterilization rate of ultraviolet lamps is 99.9%;
- Upgrade sterilization packaging, add shading board, avoid damage caused by overflow, stay away from mold, bacteria, parasites and eggs;
- One-button operation, lamp cover switch, automatically turn off the light bulb, without harming eyes;
- Hexahedral UV reflective film, 360 degree sterilization, no dead angle
- Suitable for: disinfection of daily necessities, personal belongings, etc
- 紫外線燈的殺菌率為99.9%;
- 升級消毒包裝, 增加遮光板, 避免溢出造成的損壞, 遠離黴菌, 細菌, 寄生蟲和卵子;
- 一鍵操作, 燈罩開關, 自動關閉燈泡, 不傷害眼睛;
- 六面體紫外線反射膜, 360度殺菌, 無死角
- 適用於: 日常用品, 隨身物品等的消毒



### Specifications

Product Model 產品型號	AD
Product Function 產品功能	Sterilization disinfection 殺菌消毒
Product Material 產品材質	PU
Rated input 額定輸入	5V 2A
Power 功率	8W
Power supply 供電方式	USB charging USB充電
LED quantity LED數量	12pcs
Lamp life 燈泡壽命	10000h
LED wavelength LED波長	260-280nm
Disinfection time 消毒時間	3 minutes / time 3分鐘/次
Size 尺寸	250 * 200 * 150mm
Weight 重量	730g

### Instructions

Open the zipper and put it into the stand; put items on the stand, pull up the zipper to access the special adapter; click the disinfection button to turn on for 3 minutes to quickly disinfect and deodorize, the button light flashes for 3 minutes; after the disinfection is completed, the button light is always on and can be removed article.

**Warning: Keep the items dry, do not stack them**

拉開拉鍊放入支架; 支架上放入物品, 拉上拉鍊接入專用轉接器; 按一下消毒鍵開啟3分鐘快速消毒去味, 按鍵燈閃爍持續3分鐘; 消毒完成後按鍵燈常亮, 可取出物品。

**警告: 物品保持乾燥, 平鋪勿疊放**

## UV Disinfection Delivery Bag

### 紫外线消毒外賣包

Model: CX

#### Features:

- The sterilization rate of ultraviolet lamp was 99.9%;
- Quick disinfection in 10 minutes, USB power plug
- One-button operation, lamp cover switch, automatically turn off the light bulb, without harming eyes;
- Hexahedral UV reflective film, 360 degree sterilization without dead angle;
- Suitable for: disinfection of daily necessities, personal belongings, etc
- 紫外線燈的殺菌率為99.9%;
- 10分鐘快速消毒, USB電源插頭
- 一鍵操作, 燈罩開關, 自動關閉燈泡, 不傷眼睛;
- 六面體紫外線反射膜, 360度殺菌, 無死角;
- 適用於: 日常用品, 隨身物品等的消毒



#### Specifications

Product Model 產品型號	CX
Product Function 產品功能	Sterilization disinfection 殺菌消毒
Protection level 防護等級	Surface Waterproof 表面防水
Power 功率	5W
Wavelength 波長	253.7nm+185nm
Colour 顏色	Black 黑色
Power supply 電源供應	USB charging USB充電
Working temperature 工作溫度	0-40度
UV lamp life 紫外線燈壽命	10000-20000 (H)
Size 尺寸	400 * 300 * 300 mm
Weight 重量	1150g

#### Instructions

Open the box and put clothes and other items into the box, pull up the zipper and press the start button to start disinfection and sterilization, and take out the disinfected items after the light is off.

打開箱子將衣物等物品放進箱內, 拉好拉鍊按啟動鍵開始消毒殺菌, 燈滅後拿出消毒好的物品。

# UV Folding Disinfection Bag

## 紫外線折疊消毒包

Model: CBF

### Features:

- Balance protection switch, open the cover at an angle of 30 °, and automatically turn off the ultraviolet light to prevent the ultraviolet light from illuminating the eyes
- Sterilization and disinfection can be solved by one click, which is fast and reassuring
- Quick disinfection in 3 minutes with 99.9% bactericidal rate
- 0 radiation, 0 ozone, 0 residue, safe and easy to use, reassuring sterilization
- 平衡保護開關, 開蓋30°角自動關閉紫外線光, 防止紫外線照射到眼睛
- 殺菌·消毒一鍵解決, 快捷又放心
- 3分鐘快速消毒, 殺菌率99.9%
- 0輻射、0臭氧、0殘留, 安全易用, 安心殺菌



### Specifications

Product Model 產品型號	CBF
Product Function 產品功能	Sterilization disinfection 殺菌消毒
Power 功率	1.5W
Wavelength 波長	265-280nm
Current 電流	300mA
Power supply 電源供應	USB charging USB充電
Lamp Bead 燈珠數量	6
UV lamp life 紫外線燈壽命	20000H
Size 尺寸	240*170*140mm
Weight 重量	506g

### Instructions

Open the box and put clothes and other items into the box, pull up the zipper and press the start button to start disinfection and sterilization, and take out the disinfected items after the light is off.

打開箱子將衣物等物品放進箱內, 拉好拉鍊按啟動鍵開始消毒殺菌, 燈滅後拿出消毒好的物品。

# UV Toothbrush Sterilizer

## 紫外線牙刷消毒器

Model: CAQ

### Features:

- Four independent toothbrush holders;
  - Scientific circular arc toothbrush hanging parts make the brush "suspended" and reduce touch pollution
  - Plug free, 1500 Ma lithium battery, long-term endurance of up to 22 days;
  - Easy to install and clean .
  - Suitable for: toothbrush disinfection
- 四個獨立的牙刷架;
  - 科學的圓弧牙刷懸掛部件使刷子“懸浮”並減少接觸污染;
  - 免插電1500 Ma鋰電池,長期續航長達22天;
  - 易於安裝和清潔。
  - 適用於:牙刷消毒

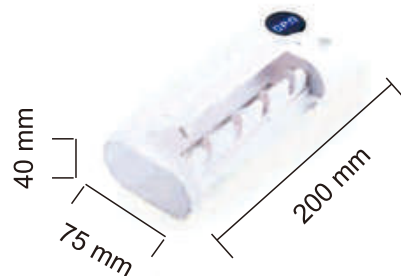

### Specifications

Product Model 產品型號	CAQ
Product Function 產品功能	Sterilization disinfection 殺菌消毒
Product Material 產品材質	ABS
Rated voltage 額定電壓	3.7V
Power 功率	3W
Battery properties 電池特性	Lithium battery 鋰電池
Battery capacity 電池容量	1500mAh
Charging time 充電時間	About 5 hours and 15 minutes 約5小時15分鐘
Service life 使用壽命	8000h
Size 尺寸	200 * 40 * 75mm
Weight 重量	200g

### Instructions

Choose the correct height and position, easy to use and connect to the power supply, keep the installation surface clean and dry before installation, stick the tape on the correct position to ensure it is firm, wait for 24 hours and hang the toothbrush sterilizer, then put the toothbrush into the sterilizer , After power on, press the button to disinfect (automatically shut down after 360 seconds), press the button again to shut down

**Warning: Do not put the toothbrush directly into disinfection when there is water**

選擇正確的高度和位置,方便使用並連接電源,安裝前保持安裝表面清潔和乾燥,將膠帶貼在正確位置確保牢固,等待24小時後掛上牙刷消毒器,這時可將牙刷放入滅菌器內,通電後按下按鍵進行消毒(360秒後自動關閉),再次按一下按鍵關機

**警告:有水的情況下不能直接放入**



# UVC Toothbrush sterilizer (Made In Korea)

## UVC 牙擦消毒機 (韓國製造)

Model: CAX

### Features:

- Four toothbrushes and razors are disinfected at the same time
- Simple and neat toothpaste holder
- New material with excellent antibacterial activity
- No need to replace the lamp semi-permanent UV LED
- Easy to install and clean
- Suitable for: toothbrush disinfection
- 四個牙刷和刮胡刀同時消毒
- 簡潔整潔的牙膏架
- 抗菌活性優良的新材料
- 無需更換燈半永久性UV LED
- 易於安裝和清潔
- 適用於：牙刷消毒

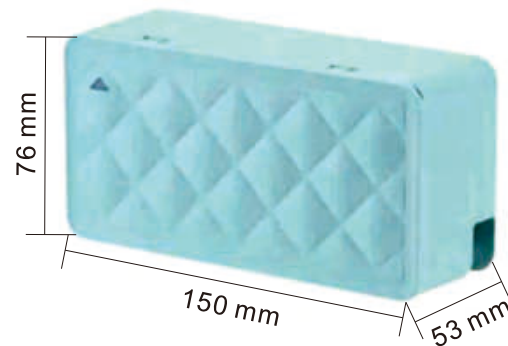

### Specifications

Product Model 產品型號	CAX
Product Function 產品功能	Sterilization disinfection 殺菌消毒
Product Material 產品材質	ABS
Power sterilization 功率滅菌	0.2W
Input Voltage 輸入電壓	DC 5V 1A
Ultraviolet wavelength 紫外線波長	UVC 254nm LED
Life 壽命	10000h
Size 尺寸	150 * 76 * 53 mm
Weight 重量	190g

### Instructions

After charging through USB cable, hang up the toothbrush Disinfection machine, then open the sterilizer cover, and put the tooth brush into the Disinfection machine. When the lid is closed, the indicator light of the device is on, indicating that the toothbrush and razor are being disinfected. The whole disinfection process takes about 10 minutes. Until the indicator light of the equipment is turned off, the disinfection is finished.

通過USB電線充電，完成後掛上牙擦消毒機，再開啟消毒器蓋子，把牙擦放入消毒機中。合上蓋子後，設備指示燈亮起表示牙擦及剃刀正在消毒。整個消毒過程約需要10分鐘。直至設備指示燈關閉，表示消毒已結束。



## UV portable toothbrush sterilizer - Mini double

### 紫外線可攜式牙刷消毒器-迷你雙人款

Model: CAU

#### Features:

- Ultraviolet UV C sterilization, bacteria removal rate of 99%
- Two person portable toothbrush sterilizer can be used at home and travel
- Rapid sterilization in 60 seconds and automatic start every 6 hours
- Stop immediately after opening the cover to prevent direct ultraviolet light from harming human body
- It can hold ordinary toothbrush and electric toothbrush, which is not loose and easy to fall
- 1.5-hour fast charging, long-time standby, one-time charging for one month
- Suitable for: toothbrush disinfection
- 紫外線uvc殺菌，細菌去除率99%
- 雙人便攜式牙刷消毒器，家居、旅行皆可使用
- 60秒快速殺菌，每6小時自動啟動一次
- 開蓋即停止，防止紫外光線直射傷害人體
- 可放普通牙刷、電動牙刷，不鬆動不易掉落
- 1.5小時快速充電，超長時間待機，充一次使用一個月
- 適用於：牙刷消毒



#### Specifications

Product Model 產品型號	CAU
Product Function 產品功能	Sterilization disinfection 殺菌消毒
Product Material 產品材質	PC+ABS
Rated input 額定輸入	DC5V/1A
Power 功率	5W
Lithium battery 鋰電池	3.7V/450mAh
Charging time 充電時間	1.5 hours 1.5小時
Ultraviolet wavelength 紫外線波長	270-285nm
Disinfection time 消毒時間	60S
Size 尺寸	75*67*40mm
Weight 重量	72g

#### Instructions

When it is sensed that the panel is closed, the start working indicator lights up white and turns off after working for one minute

When the power of the product is insufficient, the indicator light flashes red. When charging, the red indicator light flashes. After charging, the indicator light goes out

The charging time is about 1.5-2 hours, and the normal use is about 12 days

當感應到面板合上，開始工作指示燈亮白色，工作一分鐘關閉  
當產品電量不足時指示燈閃紅燈，充電時紅色指示燈呼吸閃爍，  
充電滿後指示燈熄滅  
充電時長約1.5-2小時，正常使用12天左右

# Portable LED UVC

## 可攜式手持LED UVC殺毒燈

Model: CB

### Features:

- UV sterilization in all directions, no dead corner, bacteria removal rate of 99.99%
- One button on, 360 second timing, automatic sterilization
- Portable disassembly, small and convenient, can be used as disinfection stick
- It adopts gravity induction design, with inclination > 60 ° and automatic closing
- It can be used in mask, toothbrush, jewelry, pacifier, glasses, earphone, underwear, tableware, etc
- 紫外線全方位殺菌無死角，細菌去除率99.99%
- 一鍵開啟，360秒計時，自動殺菌
- 便攜拆卸，小巧便捷，可做消毒棒
- 採用重力感應設計，傾斜度> 60°，自動關閉
- 可用於口罩、牙刷、珠寶、奶嘴、眼鏡、耳機、內衣、餐具等



### Specifications

Product Model 產品型號	CB
Product Function 產品功能	Sterilization disinfection 殺菌消毒
Material: 材質	ABS
Rated input 額定輸入	5v
Rated power 額定功率	3W
Disinfection time 消毒時間	360 s
Disinfection temp 消毒溫度	45 degrees
Power supply mode 電源方式	USB
Operation mode 操作方式	Button type 按鍵式
Size 尺寸	235 * 131 * 80 mm
Weight 重量	365g

### Instructions

Open the lid and put the items to be disinfected, click the power switch, the 360-second countdown starts, and can be turned off at any time during the period. The box disinfection lamp will automatically stop working when the box is turned on, and it will automatically sterilize after the box is closed. It can be used as a disinfection stick when it is opened.

**Warning: 1) It is prohibited to irradiate the skin and eyes of humans/animals; 2) Keep the items dry**

打开盖子放入需消毒物品，單擊電源開關，360秒倒計時開始，期間可隨時關閉，打開盒子消毒燈會自動停止工作，關閉盒子後自動殺菌，拆開後可做消毒棒使用

**警告：1) 禁止照射人體/動物等皮膚及眼睛；2) 物品保持乾燥**

# UV Sterilizer Box

## UVC紫外線消毒盒

Model: CAR

### Features:

- One button, Easy to Operate
- Fast sterilization within 300 seconds, 99.99% bacterial removal rate, 360° All-Round Sterilization with no Blind Angle,
- Preferred Gift Choice, Completely Sealed Design, No Radiation
- Multiple Use for Toothbrush, Jewelry, Pacifier, Glasses, Earphone, Underwear, Cutlery, and other accessories
- 一鍵式, 易於操作
- 300秒內快速殺菌, 細菌去除率達99.99%, 360°全方位殺菌, 無盲角,
- 首選禮物選擇, 完全密封設計, 無輻射
- 多次用於牙刷, 珠寶, 奶嘴, 眼鏡, 耳機, 內衣, 餐具和其他配件

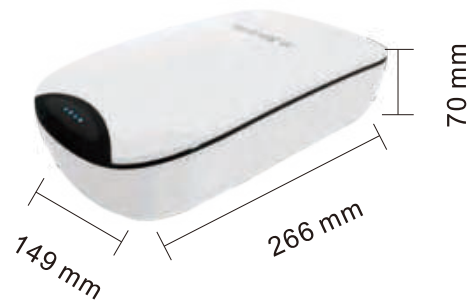

### Specifications

Product Model 產品型號	CAR
Product Function 產品功能	Sterilization disinfection 殺菌消毒
Product Material 產品材質	ABS+30%PC
UV Light Wattage 紫外線功率	2*1W
Input Voltage 輸入電壓	DC 5V
Button life 按鈕壽命	>10000 times > 10000次
Operate type 操作類型	Button 鈕扣
Sterilization Time 滅菌時間	5 Mins
Maximum Capacity 最大容量	0.95L
Size 尺寸	266 * 149 * 70mm
Weight 重量	300g

### Instructions

Turn on the power of the sterilizer, the 4 LED indicators flash once, open the lid, put the items to be disinfected in, close the lid, and press the button to start disinfection. The four lights will light up one by one (75 seconds for one light) to complete within 5 minutes (300 seconds). Device shuts down automatically

打開滅菌器電源, 4個LED指示燈閃爍一次, 打開蓋子, 把需要消毒物品放入, 閉蓋, 按一下按鈕開始消毒。四燈逐一點亮(一燈點亮需要75秒)5分鐘(300秒)內完成。裝置自動關閉

# UVC Mite Removal Robot

## UVC紫外線除蟎機器人

Model: CV

### Features:

- Can be handheld or placed in automatic mode
- 10 sensors, intelligent path detection, light objects are still moving forward
- 2 UVC anti-virus mercury lamps, bactericidal rate and mite-killing rate  $\geq 99.9\%$
- The infrared sensor senses the edge to prevent falling, and automatically sterilizes and removes mites to free your hands
- Product use: household dining table, floor, kitchen tableware, carpet, bed, carry on business trip

- 可手持也可放置開啟自動模式
- 10個感測器，智能探路，輕物壓身依然前行
- 2個UVC殺毒汞燈，殺菌率殺蟎率 $\geq 99.9\%$
- 紅外感測器感應邊緣防止跌落，自動殺菌除蟎可解放雙手
- 產品用途：家居餐桌，地板，廚房餐具，地毯，床，出差旅遊隨身攜帶

### Specifications

Product Model 產品型號	CV
Product Function 產品功能	Sterilization disinfection 殺菌消毒
Product Material 產品材質	PC+ABS + quartz glass
Rated voltage 額定電壓	5V,1A
Power 功率	2.1W (manual) 3.4W(automatic)
Lamp 燈	Quartz glass tube 石英玻璃管
Wavelength 波長	253.7nm
UV intensity 紫外線強度	2900/M
Size 尺寸	16*16*5cm
Weight 重量	400g



### Instructions

**Warning: Do not use the disinfection, sterilization and mite removal robot as a toy for children or babies, and do not direct the UVC light to the eyes**

Click, handheld mode palm artifact, scan and remove mites

Double-click, automatic mode intelligent obstacle avoidance, automatic sterilization and removal of mites at 30 minutes

**警告：**

不要把消毒殺菌除蟎機器人當成小孩或者嬰兒的玩具，UVC燈光不要直射眼睛

按一下，手持模式掌心神器，掃描除蟎

按兩下，自動模式智能避障，30分鐘定時自動殺菌除蟎

## Hand held bed ultraviolet sterilizer

### 手持床上紫外線殺菌除蟎儀

Model: CY

#### Features:

- High frequency tapping, 12800 times / min, powerful double head tapping, more thorough cleaning effect
- UV sterilization is up to 99%. When not in use, UC lamp will automatically turn off to avoid hurting human body
- The super strong suction of 85000 RPM high-speed brushless motor comes from the powerful core
- The sunken design closely fits the surface of the mattress, and the 20cm open suction port ensures better suction effect
- High precision filtration to remove clean air
- All water washing, no consumables, simple and convenient
- Suitable for: disinfection of bed, sofa, etc
- 高頻率拍打, 12800次/分鐘, 強力雙頭拍打, 清潔效果更徹底
- UV殺菌高達99%, 不用時UC燈自動關閉, 避免傷害人體
- 8.5萬轉高速無刷馬達 超強吸力源於強大內核
- 下沉式設計緊密貼合床褥表面, 20CM敞開式吸口, 保證更佳吸入效果
- 高精過濾, 排除潔淨空氣
- 全水洗, 無耗材, 簡單方便
- 適用於: 床上, 沙發等消毒



#### Specifications

Product Model 產品型號	CY
Product Function 產品功能	Sterilization disinfection 殺菌消毒
Product Material 產品材質	ABS
Wavelength 波長	253.7nm+185nm
Rated voltage 額定電壓	220V
Rated power 額定功率	300W
Rated frequency 額定頻率	50~60hz
Power cord length 電源線長度	4 meters
Power mode 電源方式	In line 直插式
Size 尺寸	340*250*290mm
Weight 重量	1.75kg

#### Instructions

Place the machine at the place where sterilization is needed, turn on the switch to ensure that the safety switch of the machine is pressed into the machine body, then turn on the power to start working, push and pull the machine back and forth (the speed is less than 20 seconds per meter, and wash it back and forth for 3 times)  
Clean the dust cover: take out the filter, brush the dust in the gap of the pot filter with a brush, or clean it with clean water if necessary, and then dry it

將機器放在需要殺菌除蟎的地方打開開關, 確保機器的安全開關壓入機身, 然後打開電源開始工作, 來回推拉機器 (速度小於每米20秒, 來回清洗3次)  
清洗防塵蓋: 取出過濾器, 用刷子將銅濾器縫隙中的灰塵刷乾淨, 必要時, 用清水清洗也可, 然後晾乾

# Book disinfection cabinet

## 圖書消毒櫃

Model: CAV

### Features:

- Microcomputer control, one button start, automatic disinfection
- It adopts all steel structure, with stable structure, good sealing and beautiful appearance
- Using advanced technology and excellent material selection, the service life is about 28000 hours
- Disinfection and sterilization has no dead corner, high disinfection efficiency, and the concentration is stable within the minimum concentration meeting the disinfection requirements
- After the decomposition period, there is no secondary pollution to the high-capacity cabinet, which ensures the cutting capacity and beauty
- Suitable for: disinfection of books, daily necessities, etc
- 微電腦控制，一鍵式啟動，自動消毒
- 採用全鋼結構，結構穩定，密封性好，外形美觀大方
- 採用先進的工藝和優良的選材，使用壽命約28000小時
- 消毒滅菌無死角，消毒效率高，濃度穩定在滿足消毒要求的最小濃度內
- 分解期後無二次污染大容量櫃體，保證了承載能力又不失美觀
- 適用於：書本，日常用品等消毒

### Specifications

Product Model 產品型號	CAV
Product Function 產品功能	Sterilization Disinfection 殺菌消毒
Material 材質	1.2mm cold rolled steel sheet 1.2mm冷軋鋼板
Rated power 額定功率	25W
Voltage 電壓	220V 50Hz
Internal volume 內容積	200L
Pallet layers 托盤層數	2 layers 2層
Tray load 托盤承重	15kg / layer 15kg/層
Product size 產品尺寸	980*550*510mm
Product weight 產品重量	37kg



### Instructions

Plug the power cord into a 220V / 50Hz well grounded socket  
Turn on the power switch, the display displays the disinfection time set internally, and adjust the disinfection time as needed  
After the items to be disinfected are placed, close the equipment door, press the "start" button to start the equipment and start the countdown display on the display  
To stop disinfection, press the "pause" button  
When the disinfection operation is completed, the display displays 60, and the equipment automatically sends out two "drip" alarms to prompt that the disinfection is completed

將電源線插入220V/50HZ有良好接地的插座  
開啟電源開關，顯示器顯示內部設定的消毒時間，根據需要調整消毒時間  
在需消毒物品放置完畢，關上設備門，按“啟動”按鈕啟動設備開始工作，顯示器開始倒數計時顯示  
想停止消毒工作，可按“暫停”按鈕  
消毒工作運行完畢時，顯示器顯示60，設備自動發出2聲“滴”報警聲，提示消毒完畢



# UVC+Ozone Sterilization-Shoes Dryer and Sterilizer

## 紫外線UVC+臭氧殺菌-鞋子烘乾消毒器

Model: CG

### Features:

- Ozone sterilization and deodorization + ultraviolet sterilization + heating and drying
  - Sterilize and dry regularly, turn off automatically when time is up
  - Intelligent temperature control throughout the whole process, dual temperature sensors intelligent control temperature detection
  - Range of use: (1). The place in the shoes that needs to be disinfected, deodorized and dry. (2). Disinfect shoe cabinets, cabinets and other enclosed small spaces. (3). Disinfection of car space, trunk, etc.
- 臭氧殺菌除臭+紫外線殺菌+加熱烘乾
  - 定時殺菌和烘乾,時間到自動關閉
  - 全程智能恆溫控制,雙溫度感測器智控溫度檢測
  - 使用範圍:(1). 鞋內需要消毒、除臭、乾燥的地方。(2). 消毒鞋櫃、櫥櫃和其他封閉的小空間。(3). 汽車空間、後備箱等的消毒



### Specifications

Product Model 產品型號	CG
Product Function 產品功能	Sterilization disinfection 殺菌消毒
Product Material 產品材質	ABS
Working temperature 工作溫度	0-45°C
Input power 輸入功率	10W
Ultraviolet wavelength 紫外線波長	253.7nm
Life 壽命	>3000H
Package Size 包裝尺寸	80 * 110 * 133 mm
Weight 重量	142g

### Instructions

Press the sterilization switch, the default time limit is 15 minutes; press twice to display 30 minutes, press three times to return to 15 minutes; press the heating switch, the default time limit is 30 minutes, press again, the set time is 60/120 minutes, 4H, 6H, 9H, 12H, 30 minutes in a loop, until the selected time; press the switch button to end the sterilization in advance, or continue to use until the end of the selected time

**Warning: When using the sterilization function, it is forbidden to irradiate eyes and skin. Please leave the scene within 10 seconds to avoid damage to people, animals and plants caused by ultraviolet rays and ozone; please keep it out of children's reach;**

按下殺菌開關, 默認限時15分鐘; 按兩下, 顯示30分鐘, 按三下則返回15分; 按下加熱開關, 默認限時30分鐘, 再次重複按下, 則定時在60/120分鐘、4H、6H、9H、12H、30分之間迴圈, 直至選定的時間; 按下開關按鍵可提前結束殺菌消毒, 或者持續使用直至選定的時間結束

**警告: 在使用殺菌功能時, 禁止照射眼睛和皮膚, 請在10秒內離開現場, 避免紫外線及產生的臭氧對人或動植物造成傷害; 請放在孩子夠不到的地方;**

# IR Sensor Hand Washing Machine

## 紅外自動感應洗手器

**Model: CD**

### Features:

- Infrared induction, small waist design, touch switch, convenient sterilization
  - Available 84 disinfectant, 75% alcohol, hypochlorous acid disposable disinfectant
  - Scientifically and reasonably control the liquid output, save the amount and avoid waste
  - Oblique angle design, better human-computer interaction perspective, just reach out to avoid touching the body
  - Suitable for multi-person scenarios such as home office
- 
- 紅外感應, 小蠻腰設計, 觸控開關, 殺菌方便
  - 可用84消毒液, 75%酒精, 次氯酸免洗消毒液
  - 科學合理控制出液量, 節省用量, 避免浪費
  - 斜角設計, 更好的人機交互視角, 伸手即可, 避免觸碰機身
  - 適合家庭辦公等多人適用場景



### Specifications

Product Model 產品型號	CD
Product Function 產品功能	Sterilization Disinfection 殺菌消毒
Material 材質	ABS+PP
Capacity 容量	500ML
Control Method 控制方式	Automatic Induction 自動感應
Power Supply 電源	4 AA batteries 4節5號電池
Capacity 產品尺寸	105 * 87 * 205 mm
Weight 重量	300g

### Instructions

After installing the battery correctly, click the power button (white light is on)  
 Move the palm of your hand to the sensing area. The hand is close to the sensing area. The machine automatically sprays without pressing. The sensing distance is 3-5cm, and the disinfectant is sprayed

正確安裝電池後, 單擊電源開關鍵(白燈亮)  
 將手心移至感應區, 手部靠近感應區, 機器自動噴灑, 無需按壓, 感應距離3-5cm, 噴灑消毒劑



## Wall-mounted Automatic Sensor Hand Washing Machine

### 壁掛式紅外自動感應洗手機

Model: CF

#### Features:

- Environmental protection and safety, corrosion resistance, insulation current, large capacity inner tank, not easy to deform
- Intelligent sensing, zero contact, avoid cross infection
- Intelligent start and stop, safe and energy-saving, atomized liquid, more material saving, just right humidity
- Small size, space saving, more convenient and flexible installation, disinfectant, clean water, soap, etc. can be used

Applicable to: offices, toilets, restaurants and other public places

- 環保安全，耐腐蝕，絕緣電流，大容量內膽，不易變形
- 智能感應，零接觸，避免交叉感染的發生
- 智能啟停，安全節能，霧化出液，更省材料，濕潤度正好
- 體積小，省空間，安裝更方便靈活，可用消毒液，清水，皂液等

適用於：辦公室，衛生間，餐廳等公共場所

#### Specifications

Product Model 產品型號	CF
Product Function 產品功能	Sterilization Disinfection 殺菌消毒
Material 材質	ABS
Capacity 容量	1000ML
Control Method 控制方式	Automatic Induction 自動感應
Power Supply 電源	4 AA batteries + DC power supply 4節5號電池+DC電源
Capacity 產品尺寸	130 * 127 * 270 mm
Weight 重量	926g



#### Instructions

Use the safety key to open the product panel from the top, uncover the inner tank and add the required liquid, squeeze out the air until the liquid flows out and close the product panel, turn on the power, and turn on the liquid automatically when the hand is turned off.

用安全鑰匙從頂部打開產品面板，揭開內膽加入所需液體，擠壓出空氣直到液體流出合上產品面板即可，接通電源，手到自動開啟出液也，手離自動關閉

# Contact Free Hand Washing Machine

## 免接触感应洗手機(凝膠款)

**Model: CAW**

### Features:

- The top intelligent switch and mode key can be switched at one press
- One second liquid output: two modes: touch to switch between more liquid volume and less liquid volume, cleaning and no waste
- 10 degree inclination nozzle, foam non stick machine
- Intelligent light sensing, low energy consumption, 4 AA batteries, available for two months
- Transparent liquid storage tank, easy to see the contents
- Applicable to: offices, toilets, restaurants and other public places
- 頂部智能開關及模式鍵一按即可隨心切換
- 一秒出液：兩種模式輕觸切換多液量及少液量，清潔不浪費
- 10°傾角噴嘴，泡沫不粘機
- 智能輕感應，低耗能，4節AA電池，可用兩個月
- 透明儲液倉，輕鬆看到內容物
- 適用於：辦公室，衛生間，餐廳等公共場所

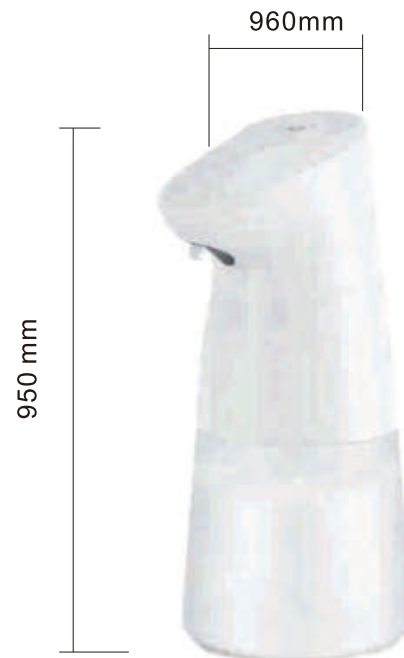

### Specifications

Product Model 產品型號	CAW
Product Function 產品功能	Sterilization Disinfection 殺菌消毒
Material 材質	ABS+PET
Capacity 容量	450ml
Control Method 控制方式	Infrared induction紅外感應
Power Supply 電源	4 AA batteries 4節5號電池
Voltage 電壓	4V
Sensing distance 感應距離	2-3CM
Capacity 產品尺寸	95*95*210mm
Weight 重量	226g

### Instructions

Open the battery cover, insert 4 AA batteries correctly, and pay attention to the positive and negative poles  
 Power on: press the power switch button once, and the ice blue light is on for multi light mode  
 Touch the switch for the second time, and the green light is on, which is a small number mode  
 Tap the power button for the third time to shut down (the red indicator flashes)  
 Prompt: when the soap dispenser does not work, it will automatically enter the standby state without manual closing  
 打開電池罩，正確插入4節AA電池，注意正負極  
 開機：按電源開關按鈕一次，冰藍燈亮為多亮模式  
 第二次輕觸開關，綠燈亮為少量模式  
 輕觸第三次電源按鈕開機（紅色指示燈閃爍）  
 提示：皂液器不工作時將自動進入待機狀態，無需手動關

## UV Electric Shock Mosquito Killer Lamp

### UV電擊式滅蚊燈

Model: CBH

#### Features:

- Portable design, built-in lithium battery, no fear of mosquitoes when traveling, camping and picnicking
  - 360° no dead angle mosquito trap, 3 turbo charged engine, large killing range, no return for mosquitoes.
  - Sleeping all night, the bass operation is not detected by mosquitoes, and there are no mosquitoes all night.
  - Visual mosquito storage box, detachable for cleaning, and mosquito bodies can be washed immediately
- 手提設計, 內置鋰電池, 外出旅遊、露宿、野炊不懼蚊
  - 360°無死角誘蚊, 採用3渦輪增壓引擎, 捕殺範圍大, 蚊子有來無回。
  - 靜眠整夜, 低音運行不被蚊蟲察覺, 整晚默默無蚊。
  - 可視化儲蚊盒, 可拆卸清洗, 蚊蟲屍體一沖即淨



#### Specifications

Product Model 產品型號	CBH
Product Function 產品功能	Sterilization Disinfection 殺菌消毒
Rated Power 額定功率	5W
Rated Voltage 額定電壓	DC 5V
Mosquito Control 滅蚊驅蚊方式	光波誘蚊+電擊滅蚊
Optical Band 納米光波段	360-375nm
Effective Distance 有效距離	15m
Capacity 產品尺寸	100*100*190mm
Weight 重量	270g

#### Instructions

Click the ON key to start the machine. When the machine is started, the strong light attracts the mosquito lamp. Click the ON key again, the weak light attracts the mosquito lamp. The third click is the lighting lamp.

Precautions:

1. Please open it in advance (at least 2 hours) before use,
2. It is better to use it in an unmanned environment, because human body temperature and smell can easily attract mosquitoes.

單擊開關鍵即開機, 開機即強光吸蚊燈, 再次單擊開關鍵即弱光吸蚊燈, 第三次單擊為照明燈。

注意事項:

1. 使用前請提前開啟(至少2小時),
2. 在無人的環境使用更佳, 因為人的體溫和氣味較容易能吸引蚊蟲。

# Rotatable UV Electric Mosquito Swatter

## 可旋轉UV誘蚊電蚊拍

**Model: CBI**

### Features:

- 90 degree mosquito control without dead angle
  - Two modes of direction adjustment+mosquito trap lamp and intelligent mosquito killing can better protect the long night
  - Safety design, double safety switch, press and hold the button to kill mosquitoes
  - New plastic mesh dual protection design, only electric mosquitoes, not electric people
- 
- 90度無死角滅蚊
  - 方向調節+誘蚊燈和智能滅蚊兩種模式,更好守護漫漫長夜
  - 安全設計, 雙重保險開關, 按住按鈕即可滅蚊
  - 全新的塑網雙重防護設計, 只電蚊蟲不電人



### Specifications

Product Model 產品型號	CBI
Product Function 產品功能	To Lure And Kill Mosquitoes 誘蚊殺蚊
Voltage 電壓	DC5V
Endurance 續航時間	8-12H
Mosquito Control 滅蚊驅蚊方式	光波誘蚊+電擊滅蚊
Applicable Area 適用面積	20-50m <sup>2</sup>
Rotation Angle 旋轉角度	0-90°
Capacity 產品尺寸	240*445*30mm
Weight 重量	260g

### Instructions

Move the "mosquito trap lamp and electric shock standby gear" or "electric shock standby gear" and then press and hold the electric shock start button, and the electric shock indicator light will display red; Standby mode/shutdown mode: the electric shock lamp does not light up.

Press and hold the electric mosquito startup button to enter the electric mosquito electric shock mode by turning the "electric shock standby gear".

Toggle the "mosquito trap lamp and electric shock standby gear" mosquito trap lamp and press the start button of the electric mosquito to enter the electric shock mode of the electric mosquito.

撥動“誘蚊燈和電擊待機檔”或“擊待機檔”再按住電擊啟動鍵,電擊工作指示燈顯示紅色;待機狀態,電擊燈不亮,關機狀態,電擊燈不亮。

撥動“電擊待機檔”按住電蚊啟動按鈕進入電蚊電擊模式。

撥動“誘蚊燈和電擊待機檔”誘蚊燈按住電蚊啟動按鈕,進入電蚊電擊模式。

## Wall Mounted Tableware Sterilizer

### 壁掛式餐具殺菌消毒機

Model: CBJ

#### Features:

- Fully enclosed design to prevent secondary invasion of foreign bacteria
  - Safe mercury free ultraviolet sterilization, powerful fan drying and dehumidification, dual three-dimensional loop sterilization
  - Column design, small size, large capacity, easy to meet the needs of the family
  - Built in drain basket, which is breathable and clean to prevent mildew
- 全封閉式設計，防止外來細菌二次侵入
  - 安全無汞紫外線除菌，強力風扇抽幹除濕，雙重立體迴圈除菌
  - 分欄設計，小身材、大容量，輕鬆滿足全家需要
  - 內置瀝水籃，瀝水透氣，乾淨衛生，防止發黴

#### Specifications

Product Model 產品型號	CBJ
Product Function 產品功能	Sterilization Disinfection 殺菌消毒
Material 材質	PP+ABS
Rated Power 額定功率	5W
Rated Voltage 額定電壓	5V
Battery Capacity 電池容量	2400ma
Capacity 產品尺寸	195*80*293mm
Weight 重量	540g



#### Instructions

Press the switch to start, start immediately, it is the first gear, the indicator light is white, the working state is always on, and the waiting state is breathing. At the same time, start the fan and the UV light (with an interval of 0.2s). The fan start time is 5 minutes, the UV light is 10 minutes, and then start the UV light every 2 hours (the first gear is the loop gear, and the fan only starts once). The loop cycle of the first gear is 24 hours.

打開翻蓋，根據需要把筷子、勺子放於位置內，並蓋上翻蓋。  
按開關為啟動，即刻啟動，為一檔，指示燈為白燈，工作狀態為常亮，等待狀態為呼吸，同時啟動風機和紫外線燈(間隔0.2s)，風機啟動時間為5分鐘，紫外線燈為10分鐘，然後每隔2個小時啟動紫外線燈(1檔為迴圈檔，風機只啟動一次)，一檔迴圈週期為24小時。

# Multi Function Tool Sterilizer

## 家用多功能刀具消毒器

**Model: CBN**

### Features:

- It is a kitchen shelf that can be sterilized and dried, and can store kitchen knife sets daily
- It can air dry and sterilize common kitchenware, reduce the chance of mildew and prevent bacteria from breeding
- Ultraviolet radiation+fan system, which needs to be plugged in for sterilization
- It takes about 2 hours to dry and 30 minutes to sterilize, and the work will automatically end after completion
- 是可殺菌風乾的廚房用置物架，日常可存儲廚房刀具套裝
- 可對常用廚具進行風乾和殺菌，減少發黴幾率，阻止細菌的等滋生，繁殖
- 紫外線照射+風扇系統，殺菌需插電使用
- USB款風乾約需2小時，殺菌約需30分鐘，完成後會自動結束工作

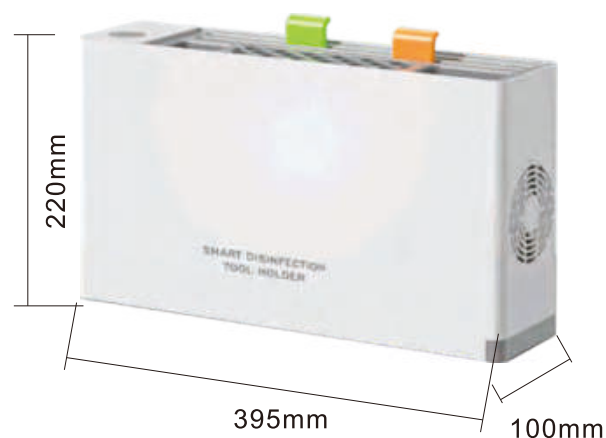

### Specifications

Product Model 產品型號	CBN
Product Function 產品功能	Sterilization Disinfection 殺菌消毒
Material 材質	PA+PP+ABS
Lamp Bead 燈珠類型	5顆LED
Working Principle 工作原理	UV+air Drying 紫外線+風乾
Rated Power 額定功率	4.5W
Voltage 電壓	5V
Capacity 產品尺寸	395*100*220mm
Weight 重量	1669g

### Instructions

Please power on first. Tools, chopsticks, knives and forks should be washed, dried and put in. Press the key to start the operation, and the display light is on. The default operation of USB model takes about 2 hours, and will automatically end after completion.

請先通電。刀具、筷子、刀叉等需沖洗後擦幹放入。按鍵開啟工作，顯示燈亮，USB款默認工作約需2小時，完成後會自動結束。

---

# Air purification

## 空氣淨化





# Anion Air Purifier

## 負離子空氣淨化器

Model: FAR

### Features:

- Small size and portable; silent operation, high cost performance;
- Intelligent display, adjustable gear; 200 million level negative ion emitter ;
- The necklace is made of food grade 304 stainless steel, which is environment-friendly, firm and not easy to break;
- No consumables and no replacement of anion generator for life;
- Suitable for: portable use
- 體積小, 攜帶方便; 操作優良, 性價比高;
- 智能顯示, 可調檔位; 2億液位負離子發射器;
- 項鍊由食品級304不銹鋼製成, 環保, 牢固, 不易斷裂。
- 無需消耗品, 終身不更換陰離子發生器;
- 適用於: 隨身使用

### Specifications

Product Model 產品型號	FAR
Product Function 產品功能	Air purification 空氣淨化
Product Material 產品材質	ABS + PC
Power 功率	1W
Anion concentration 陰離子濃度	16000w / m <sup>3</sup>
Rated frequency 額定頻率	50 (Hz)
Battery capacity 電池容量	700mah
Duration 持續時間	High concentration 30 hours, low concentration 60 hours 高濃度30小時, 低濃度60小時
Size 尺寸	80 * 35 * 23 mm
Weight 重量	48g



### Instructions

Lightly press the button to turn on, the power indicator lights up in blue, and the negative ion level low mode is activated at the same time; then lightly press the button to switch to the negative ion high level mode, and the third time to lightly press the button to shut down

**Warning: Do not let liquid enter the machine; keep away from heat sources; do not use it under quilts or blankets; people with heart diseases or pacemakers are prohibited from using this product**

輕按按鍵開機, 電源指示亮藍燈, 同時啟動負離子等級低模式; 再輕按按鍵切換到負離子高檔模式, 第三次輕按按鍵則關機  
警告: 不要使液體進入機器; 遠離熱源; 不要在被子或毯子下使用; 心臟病或佩戴有心臟起搏器的人禁止使用本產品

# Anion Air Purifier

## 負離子空氣淨化器

Model: AK

### Features:

- Small size and portable; Intelligent display, adjustable gear; Silent operation, high cost performance;
- Ten million level negative ion emitter;
- The necklace is made of food grade 304 stainless steel, which is environment-friendly, firm and not easy to break;
- No consumables and no replacement of anion generator for life;

Suitable for: portable use

- 體積小巧便攜; 智能顯示, 齒輪可調; 操作優良, 性價比高;
  - 千萬級負離子發射器;
  - 項鍊由食品級304不銹鋼製成, 環保, 牢固, 不易斷裂。
  - 無需消耗品, 終身不更換陰離子發生器;
- 適用於: 隨身使用

### Specifications

Product Model 產品型號	AK
Product Function 產品功能	Air purification 空氣淨化
Product Material 產品材質	ABS + PC
Power 功率	Less than 1W 小於1W
Anion concentration 陰離子濃度	4000W/ m <sup>3</sup>
Rated frequency 額定頻率	50 (Hz)
Battery capacity 電池容量	230mAH
Charging time 充電時間	2 hours
Charging mode 充電方式	Type-C charging C型充電
Size 尺寸	52 * 48 * 23mm
Weight 重量	34g



### Instructions

Click the power button to turn on the device, the power indicator turns blue, click the power button again to turn off the device, and the power indicator turns off

**Warning: Do not allow liquids to enter the machine; keep away from heat; do not use under quilts or blankets; people with heart diseases or pacemakers are prohibited from using this product**

單擊電源按鈕打開設備, 電源指示燈變藍, 再次單擊電源按鈕關掉設備, 電源指示燈關閉

**警告: 不要使液體進入機器; 遠離熱源; 不要在被子或毯子下使用; 心臟病或佩戴有心臟起搏器的人禁止使用本產品**

# Anion Air Purifier

## 負離子空氣淨化器

Model: AJ

### Features:

- Small size and portable;ilent operation, high cost performance;
- Intelligent display, adjustable gear;Five million negative ion emitter;
- The necklace is made of food grade 304 stainless steel, which is environment-friendly, firm and not easy to break;
- No consumables and no replacement of anion generator for life;
- Suitable for: portable use
- 體積小, 攜帶方便;操作靜音, 性價比高;
- 智能顯示, 可調檔位;五百萬個負離子發射器;
- 項鍊由食品級304不銹鋼製成, 環保, 牢固, 不易斷裂。
- 無需消耗品, 終身不更換陰離子發生器;
- 適用於: 隨身使用

### Specifications

Product Model 產品型號	AJ
Product Function 產品功能	Air purification 空氣淨化
Product Material 產品材質	ABS
Power 功率	Less than 1W 小於1W
Anion concentration 陰離子濃度	300W/ m <sup>3</sup>
Rated frequency 額定頻率	50 (Hz)
Battery capacity 電池容量	200mA
Charging time 充電時間	2 hours
Charging mode 充電方式	USB
Size 尺寸	58 * 25 * 23mm
Weight 重量	28g



### Instructions

Click the power button to turn on the device, the power indicator turns blue, click the power button again to turn off the device, and the power indicator turns off

**Warning: Do not allow liquids to enter the machine; keep away from heat; do not use under quilts or blankets; people with heart diseases or pacemakers are prohibited from using this product**

單擊電源按鈕打開設備, 電源指示燈變藍, 再次單擊電源按鈕關掉設備, 電源指示燈關閉

**警告: 不要使液體進入機器; 遠離熱源; 不要在被子或毯子下使用; 心臟病或佩戴有心臟起搏器的人禁止使用本產品**

## Anion Air Purifier

### 負離子空氣淨化器

Model: CBK

#### Features:

- Quickly and effectively resist and eliminate harmful substances, and purify air pollutants within 3-5 m<sup>2</sup>
  - Small size, easy to carry and operate
  - Ten million level negative ion emitter
  - Double sterilization: UVC ultraviolet ray sterilization mechanism, which can quickly eliminate bacteria and viruses
- 快速有效抵擋、消除有害物質，淨化3-5m<sup>2</sup>內空氣污染物
  - 體積小，攜帶方便，操作簡單
  - 千萬級負離子發射極
  - 雙重殺菌：UVC紫外線除菌機制，快速消滅細菌及病毒

#### Specifications

Product Model 產品型號	CBK
Product Function 產品功能	Air purification 空氣淨化
Product Material 產品材質	ABS
Power 功率	Less than 1W 小於1W
Anion concentration 陰離子濃度	2800W/cm <sup>3</sup>
Battery capacity 電池容量	500mAh
Duration 使用時長	30 hours
Charging mode 充電方式	USB charging USB充電
Size 尺寸	88×30×17mm
Weight 重量	40g

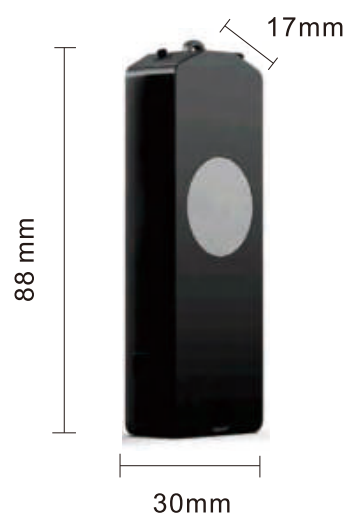

#### Instructions

Long press the disinfection lamp button for 1.5 seconds to start the disinfection function;  
Press and hold the disinfection lamp button for 0.3 seconds to turn off the disinfection function.  
Press and hold the anion generation button for 1.5 seconds to turn on the anion generation function;  
Press and hold the anion generation button for 0.3 seconds to turn off the anion generation function.

長按消毒燈按鍵1.5秒，開啟消毒功能；  
長按消毒燈按鍵0.3秒，關閉消毒功能。  
長按負離子產生按鍵1.5秒，開啟負離子產生功能；  
長按負離子產生按鍵0.3秒，關閉負離子產生功能。

# UV Air Purifier

## 紫外線空氣淨化器

### Model: FAQ

#### Features:

- Fashionable appearance , exquisite and compact , no space occupied;Ultra-low power consumption ,
  - Built in ultraviolet light , no escaping sterilization , safe , efficient and thorough purification
  - USB ultra-low voltage power supply, safe and no electric shock,short circuit doesn't cause spontaneous combustion
  - Ultra quiet design , doesn't affect sleep at all.
  - Applicable to: bedroom, bathroom, office and other living spaces
- 
- 外觀時尚,精緻小巧,不佔空間;超低功耗,
  - 內置紫外線,無逃逸殺菌,安全高效徹底淨化
  - USB超低壓電源,安全無觸電,短路不引起自燃
  - 超漂亮的設計,根本不影響睡眠。
  - 適用於:臥室,衛生間,辦公室等生活空間

#### Specifications

Product Model 產品型號	FAQ
Product Function 產品功能	Air purification 空氣淨化
Wavelength 波長	265 nm
Rated voltage 額定電壓	5V
Rated frequency 額定頻率	50HZ
Power 功率	5W
PM CADR	70m <sup>3</sup> /h
TVOC	40m <sup>3</sup> /h
Toluene	40m <sup>3</sup> /h
Noise 噪聲	35db(A)
Size 尺寸	118 * 118 * 180mm
Weight 重量	0.5kg

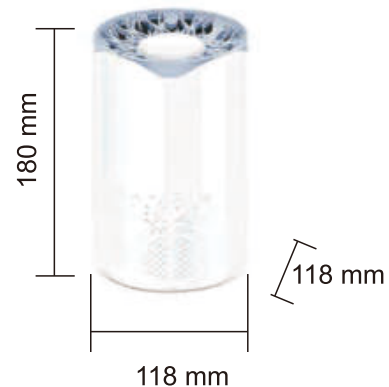

#### Instructions

Turn on when power on, turn off when power off

通電即開啟, 閉電即關閉

# Cr28 Air Disinfection Machine

## CR28紫外線空氣淨化消毒機

Model: FAI

### Features:

- Efficient composite filter(H13),sterilize rate nearly 99.99%
- Bluetooth speaker,HD sound quality, you can enjoy the music at the same time
- Efficient multi-port charging output,dual USB design,Wireless charge support at the same time when purifying
- Intelligent real time display, multifunction key, Efficient purification with low power consumption
- Applicable to: bedroom, bathroom, office and other living spaces
- 高效複合過濾器(H13),殺菌率近99.99%
- 藍牙揚聲器,高品質音質,可以同時欣賞音樂
- 高效的多端口充電輸出,雙USB設計,淨化時可同時支持無線充電
- 智能實時顯示,多功能按鍵,高效淨化,低功耗
- 適用於:臥室,衛生間,辦公室等生活空間

### Specifications

Product Model 產品型號	FAI
Product Function 產品功能	Air purification 空氣淨化
Product Material 產品材質	ABS
Super Power Saving 超級省電	0.01KWh/ Hour
Bluetooth version 藍牙版本	BT 5.0/ 10M Transmission distance BT 5.0 / 10M傳輸距離
Bluetooth Speaker 藍牙揚聲器	8W HD sound 8W高品質聲音
Charge 充電	2*5PIN USB 5V,2A
Wireless charging function 無線充電功能	700-800mAH
Charging mode 充電方式	USB
Size 尺寸	290 * 185 * 185mm
Weight 重量	1950g



### Instructions

Install the filter, learn about the control panel, press the switch button to turn on the purifier. Press the wind speed button repeatedly to switch the required wind speed, the switching sequence is low gear → middle gear → high gear. Press and hold the power button for 5s to shut down.  
**Warning: Do not enter the product with liquid or flammable cleaning agents, and do not block the air inlet and outlet**

安裝過濾器,了解控制面板,按開關按鈕打開淨化器。重複按風速鍵按鈕,切換所需的風速,切換順序為低檔→中檔→高檔。長按開機鍵5s關機。

**警告:切勿液體或易燃性清潔劑進入產品,請勿堵塞進風和出風口**

# Portable air purification and disinfection machine

## 便攜式空氣淨化消毒機

**Model: FB**

### Features:

- Capsule shape, portable and compact
- One click start, give you a clean space atmosphere day and night, and enjoy the new air
- Mute without interference, 10 dB operation, so that you can breathe healthily and sleep well when you sleep
- Suitable for living room, kitchen, bathroom, shoe cabinet, wardrobe, car and office
- 
- 太空艙造型, 便攜小巧
- 一鍵啟動, 不分晝夜的給你潔淨的空間氛圍, 淨享新空氣
- 靜音不幹擾, 10分貝運行, 讓你在睡覺的時候健康呼吸睡眠好
- 適用於客廳、廚房、衛生間、鞋櫃、衣櫃、車內、辦公室
- 



### Specifications

Product Model 產品型號	FB
Product Function 產品功能	Air purification 空氣淨化
Rated voltage 額定電壓	DC5V
Working power 工作功率	≤5W
Current 電流	≤ 800 Ma
Power supply mode 電源方式	USB
Control method 控制方式	Push button 按鍵式
Applicable space 適用空間	11m <sup>2</sup> -20m <sup>2</sup>
Active oxygen output 活氧輸出	100mg/h
Air volume 風量	51-150 m <sup>3</sup> / h
Weight 重量	280g
Size 尺寸	100*66*98mm
Weight 重量	280g

### Instructions

Long press the negative ion switch button, long drop, default standby mode, the power indicator is on, then short press the negative ion button to switch between high and low negative ion concentration mode, and short press the active oxygen button to switch between active oxygen mode

長按開關機負離子按鍵, 長滴一聲, 默認待機狀態, 電源指示燈亮, 再短按負離子按鍵切換高、低負離子濃度模式, 短按活氧按鍵切換活氧模式



# UVC Mobile Sterilization Humidifier

## UVC移動除菌加濕器

Model:FAJ

### Features:

- Three gears to adjust atomization intensity, 360 degree rotation
  - One key to turn on, smart surround, low fog humidification, silent design
  - Slim body, small and flexible, two-in-one humidification and sterilization
  - Suitable for many occasions
- 三檔調節霧化強度, 360度旋轉
  - 一鍵開啟, 智能環繞, 低霧加濕, 靜音設計
  - 纖薄機身, 小巧靈活, 加濕除菌二合一
  - 適合多種場合

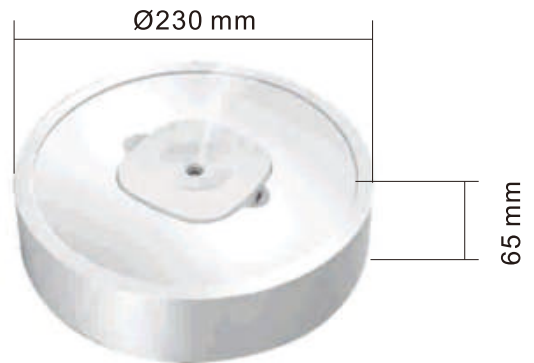

### Specifications

Product Model 產品型號	FAJ
Product Function 產品功能	humidification and sterilization 加濕除菌
Product Material 產品材質	ABS
Rated power 額定功率	2.8W
Rated voltage 額定電壓	3.7 V
Rechargeable battery 可充電電池	1200mAh
Water tank capacity 水箱容量	less than 1 liter 1升以下
Charging mode 充電方式	USB
Size 尺寸	230 * 230 * 65mm
Weight 重量	670g

### Instructions

Press the first switch to turn on the continuous long spray mode, and then press once to switch on indirect spray. Spray for 2 seconds and stop for 3 seconds. Press the mobile spray for the third time, and turn on the ultraviolet germicidal lamp at the same time to move and humidify the ultraviolet disinfection, press the fourth button to turn off the humidifier

一檔長噴模式, 二檔間噴模式, 三檔移動噴霧消毒  
按第一下開關開啟連續長噴模式, 再按一下轉換間接噴霧, 噴2秒停3秒, 第三次按移動噴霧同時開啟紫外線殺菌燈, 移動加濕紫外線殺菌消毒, 按第四下關閉加濕器

# Negative Ion Desktop Air Purifier

## 負離子臺式空氣淨化器

**Model: FAK**

### Features:

- Purify the air, absorb dust, particles, hair, pollen, deodorize, remove smoke, remove TVOC, etc.
- Kill toxic and harmful carcinogens
- Increase the oxygen content in the air and produce healthy ions
- Activated carbon deodorizing fiber screening program can fully filter PM2.5 and formaldehyde
- Suitable for office, bedroom, study, etc.
  
- 淨化空氣, 吸收灰塵、顆粒、頭髮、花粉、除臭、除煙、除TVOC等
- 殺滅有毒有害致癌菌
- 增加空氣中的氧含量並產生健康離子
- 活性炭除臭纖維篩檢程式能充分過濾PM2.5和甲醛
- 適用於辦公室、臥室、書房等



### Specifications

Product Model 產品型號	FAK
Product Function 產品功能	Air purification 空氣淨化
Rated voltage 額定電壓	DC5V
Working power 工作功率	≤2W
Standby power 待機功率	≤0.2W
Power supply mode 電源方式	USB, car power supply USB, 車載電源
Control method 控制方式	Push button 按鍵式
Applicable space 適用空間	about 10 square meters 約10平方米
Anion output 負離子產量	5×10 <sup>6</sup> pcs/cm <sup>3</sup>
Size 尺寸	125 * 125 * 194mm
Weight 重量	520g

### Instructions

Plug the power adapter into the power socket to enter standby mode; press the "on/off" button on the top to turn on the device and turn on the decorative lights; press the on/off button again to enter sleep mode, half of the decorative lights are off, and it will automatically shut down after 8 hours; Press the On/Off button again to turn off

**Warning: It is strictly forbidden to rinse the appliance with water**

將電源適配器插入電源插座以進入待機模式; 按頂部的“開/關”按鈕可打開裝置並打開裝飾燈; 再次按開/關按鈕進入睡眠模式, 半個裝飾燈熄滅, 8小時後自動關機; 再次按下On/Off按鈕關閉

**警告: 嚴禁用水沖洗器具**

# UVC Air Purifier

## 紫外線空氣淨化器

Model: CBD

### Features:

- One machine is multi-purpose and can be plugged in and used at any time. It is applicable to all indoor occasions and can be sterilized in all directions without dead corners
- Ultra long life turbofan suction pollution, photolysis and disinfection, continuous loop purification
- Ultra low noise, better sleep and environmental protection
- Replaceable light source, longer service life
- 一機多用, 隨插隨用, 適用室內各個場合, 全方位無死角消毒
- 超長壽命的渦輪風扇吸入污染再光解消毒, 持續迴圈淨化
- 超低噪音, 更好眠更環保
- 可更換式光源, 使用壽命更長

### Specifications

Product Model 產品型號	CBD
Product Function 產品功能	Air purification 空氣淨化
Rated voltage 額定電壓	DC5V
Working power 工作功率	4.5W
Power supply mode 電源方式	USB
Wavelength 波長	253nm
Size 尺寸	190*65*65mm
Weight 重量	225g



### Instructions

USB plug-in

USB插電使用

# Ozone Refrigerator Active Purifier

## 負離子臺式空氣淨化器

**Model: FAL**

### Features:

- Eliminate residues, quickly deodorize, kill bacteria, and extend freshness
- Say goodbye to peculiar smell, long-term use, no energy consumption, no secondary pollution
- Suitable for refrigerator, wardrobe, shoe cabinet, kitchen, bathroom
- 祛除殘留, 快速除臭, 殺滅細菌, 延長保鮮
- 告別異味, 長期使用, 無耗能, 無二次污染
- 適用於冰箱、衣櫃、鞋櫃、廚房、衛生間

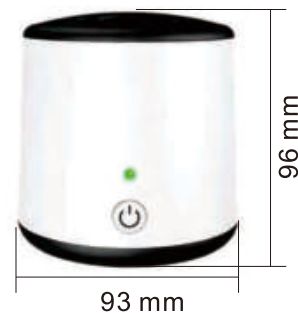

### Specifications

Product Model 產品型號	FAL
Product Function 產品功能	Air purification 空氣淨化
Rated voltage 額定電壓	DC5V
Power 功率	≤0.5 W
Ozone output 臭氧輸出	5mg/h
Power supply mode 電源方式	4 AA batteries 4節AA電池
Air purifier air volume 空氣淨化器風量	50 cubic meters/hour 50 立方米/小時
Noise 噪音	20 (dB)
Size 尺寸	93 * 93 * 96mm
Weight 重量	150g

### Instructions

Click the switch indicator to light green, the machine will work for 10 minutes and stop for 20 minutes (the green light flashes in the suspended state), and the machine will shut down after 12 hours of cyclic work. The second click, press the switch, the indicator light is red, and it will automatically shut down after 4 hours of work. Click the switch for the third time to shut down

**Warning: 1. USB and battery cannot be used at the same time  
2. USB cannot be used in the refrigerator.**

單擊開關指示燈亮綠色, 機器工作10分鐘停20分鐘(20分鐘暫停工作狀態時綠燈閃爍), 迴圈工作12小時後關機。第二單擊按開關指示燈亮紅色, 機器長開工作, 4小時後自動關機。第三次單擊開關為關機, 指示燈不亮, 機器停止工作。

**警告: 1、USB和電池不能同時使用 2、不能在冰箱裏使用USB。**

# Ozone Sterilizer

## 臭氧消毒器

Model: CAP

### Features:

- Ozone sterilization and odor removal;
- Decomposition formaldehyde, toluene;
- Ozone 360 ° all-round deodorization and sterilization;
- Safe, efficient and easy to carry;
- Applicable to: bedroom, bathroom, office and other living spaces
- 臭氧滅菌和去除異味;
- 分解甲醛, 甲苯;
- 臭氧360°全方位除臭殺菌;
- 安全, 高效且易於攜帶;
- 適用於: 臥室, 衛生間, 辦公室等生活空間

### Specifications

Product Model 產品型號	CAP
Product Function 產品功能	UV sterilization while purifying the air 紫外線殺菌同時淨化空氣
Product Material 產品材質	ABS + PC + silica gel ABS + PC +矽膠
Power 功率	3W
Battery capacity 電池容量	1800 mA, 18650 lithium battery 1800 mA, 18650鋰電池
Working environment 工作環境	Negative 10 to 60 degrees -10~60°
Charging line 充電線	USB - micro interface USB-微型接口
Ozone emission 臭氧排放	1 cubic meter, 1 hour, 20 mg 1立方米, 1小時, 20毫克
Built in fan 內置風扇	5015 large port blower, oil mute 5015大口徑鼓風機, 機油靜音
Size 尺寸	115 * 115 * 43mm
Weight 重量	228g



### Instructions

Long press the power button to enter the loop mode (the reminder light breathes and flashes), work for 10 minutes and stop for 8 hours, and then loop until the battery runs out and shut down automatically. In the loop deodorization mode, press the power button again to switch to the single mode (constant light), and it will automatically shut down after 20 minutes of work.

**Warning: Keep away from the working place of the ozone sterilizer**

長按電源鍵進入迴圈模式(提示燈呼吸閃亮), 工作10分鐘停8小時, 如此迴圈直到電量用完自動關機。在迴圈除臭模式下再按一下電源鍵切換到單次模式(常亮燈), 工作20分鐘後自動關機。

**警告: 請遠離臭氧滅菌器工作地方**

# Refrigerator Active Oxygen Deodorizer

## 冰箱活氧消毒除味淨化器

Model: CBL

### Features:

- Compact body, can be placed anywhere in the refrigerator
- Space loop killing, improve the degradation speed of pesticide residues, and effectively sterilize
- Dual mode sterilization and deodorization, long-term accompanying use
- Scope of application: refrigerator, car interior, shoe cabinet, wardrobe, etc
- 機身小巧, 可任意放在冰箱任何位置
- 空間迴圈消殺, 提高農殘的降解速度, 高效除菌
- 雙模式殺菌除味, 長效陪伴使用
- 適用範圍: 冰箱、車內、鞋櫃、衣櫃、等



### Specifications

Product Model 產品型號	CBL
Product Function 產品功能	UV sterilization while purifying the air 紫外線殺菌同時淨化空氣
Product Material 產品材質	PU
Rated Voltage 額定電壓	5V
Battery capacity 電池容量	1200mAh
Power Supply 供電方式	USB
Applicable Area 適用面積	<10m <sup>2</sup>
Size 尺寸	105*105*40mm
Weight 重量	96g

### Instructions

Click the on key to start the machine, and the default is the loop mode: the indicator is the blue breathing light, which works once a day, and automatically loops back once every 24 hours;

Click the switch button again for strong mode: the indicator light is always blue, and the machine will work for 10 minutes and stop for 20 minutes until there is no power

Warning: Keep away from the working place of ozone sterilizer

單擊開關鍵開機, 默認為迴圈模式: 指示燈為藍色呼吸燈, 一天工作一次, 每24小時自動迴圈一次;

再次單擊開關鍵為強力模式: 指示燈為藍色常亮, 該模式下機器工作10分鐘停20分鐘, 直到沒電為止

警告: 請遠離臭氧滅菌器工作地方

# Refrigerator Sterilizer And Deodorizer

## 冰箱殺菌除味器

Model: CBM

### Features:

- Compact body, can be placed anywhere in the refrigerator to make room for ingredients
- Space loop killing, improve the degradation speed of pesticide residues, and effectively sterilize
- Dual mode sterilization and deodorization, long-term accompanying use
- Scope of application: refrigerator, car interior, shoe cabinet, wardrobe, etc
- 機身小巧, 可任意放在冰箱任何位置, 為食材騰出空間
- 空間迴圈消殺, 提高農殘的降解速度, 高效除菌
- 雙模式殺菌除味, 長效陪伴使用
- 適用範圍: 冰箱、車內、鞋櫃、衣櫃、等

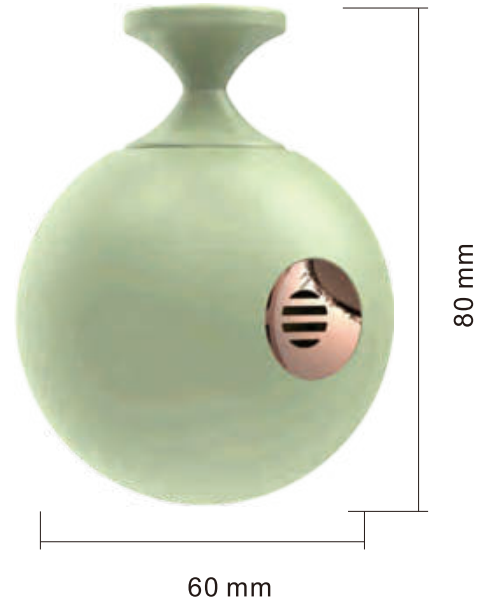

### Specifications

Product Model 產品型號	CBM
Product Function 產品功能	UV sterilization while purifying the air 紫外線殺菌同時淨化空氣
Product Material 產品材質	ABS
Power 功率	0.1W
Product Voltage 產品電壓	5V
Size 尺寸	80*60*60mm
Weight 重量	67g

### Instructions

Click the switch button, it is the loop mode: the indicator light is red, and it is turned on once every 12 hours to loop; Click again for strong mode: the indicator light is green, and the machine stops for 120 minutes after 25 minutes of operation, so as to circle.

**Warning: Keep away from the working place of ozone sterilizer**

單擊開關按鈕, 為迴圈模式: 指示燈亮紅燈, 每12小時開啟一次, 以此迴圈;  
再次單擊為強力模式: 指示燈亮綠燈, 機器工作25分鐘後停120分鐘, 以此迴圈。

**警告: 請遠離臭氧滅菌器工作地方**



# Ozone Sterilizer

## 臭氧消毒器

Model: CBO

### Features:

- Two modes of sterilization and deodorization, ozone sterilization, and taste purification are combined, which can be used together for a long time
- Small volume, no space occupation
- Multi purpose, easy to carry
- Applicable to: refrigerator, bathroom, shoe cabinet, car, etc
- 殺菌除味雙模式, 臭氧殺菌, 淨味二合一, 長效陪伴使用
- 小體積, 不占位
- 多用途, 方便攜帶
- 適用於: 冰箱、浴室、鞋櫃、車內等



### Specifications

Product Model 產品型號	CBO
Product Function 產品功能	UV sterilization while purifying the air 紫外線殺菌同時淨化空氣
Product Material 產品材質	ABS
Power 功率	0.5W
Power Supply Mode 供電方式	USB / AAA battery * 3
Working environment 工作環境	-10~45°C
Ozone Concentration 臭氧濃度	≥20PPM
Applicable Space 適用空間	<5m <sup>3</sup>
Size 尺寸	85*85*25mm
Weight 重量	60g

### Instructions

The product is powered on or equipped with three AAA batteries \*. After the correct power on, touch the switch once, the machine will work with green light, and the intelligent work will remove odor. If it is not operated again, it will automatically work until the battery is finished. Touch the switch again, the machine will work with a blue light, and it will automatically shut down after one hour of deodorization. When the machine is working, long press the switch to shut it down.

Warning: Keep away from the working place of ozone sterilizer

產品通電使用或自備AAA電池\*3節, 正確通電後, 觸碰一次開關, 機器工作亮綠燈, 智能工作除味, 不再操作將自動工作到電池完。再次觸碰開關, 機器工作亮藍燈, 除味工作1小時後自動關機。機器工作時, 長按開關即可關機。

警告: 請遠離臭氧滅菌器工作地方



**Ziglite Smart Health Care Products Co., Ltd.**  
**節亮康護產品有限公司**

Hong Kong Office Address

Room B3, 18/F Bonsun Industrial Building, 364-366 Sha Tsui Road, Tsuen Wan, Hong Kong

Office Hour : Mon - Fri : 9:30 - 5:30pm

Email : [info@ziglite.com](mailto:info@ziglite.com)

Office : +852 3107 7500

Fax: +852 3544 0462

Whatsapp : +852 6827 2010



[www.ziglite.com](http://www.ziglite.com)